

**makeCNC**



**SNOWSPEEDER**



**makeCNC**  
Robotic Tools & other Machines

[www.makecnc.com](http://www.makecnc.com)

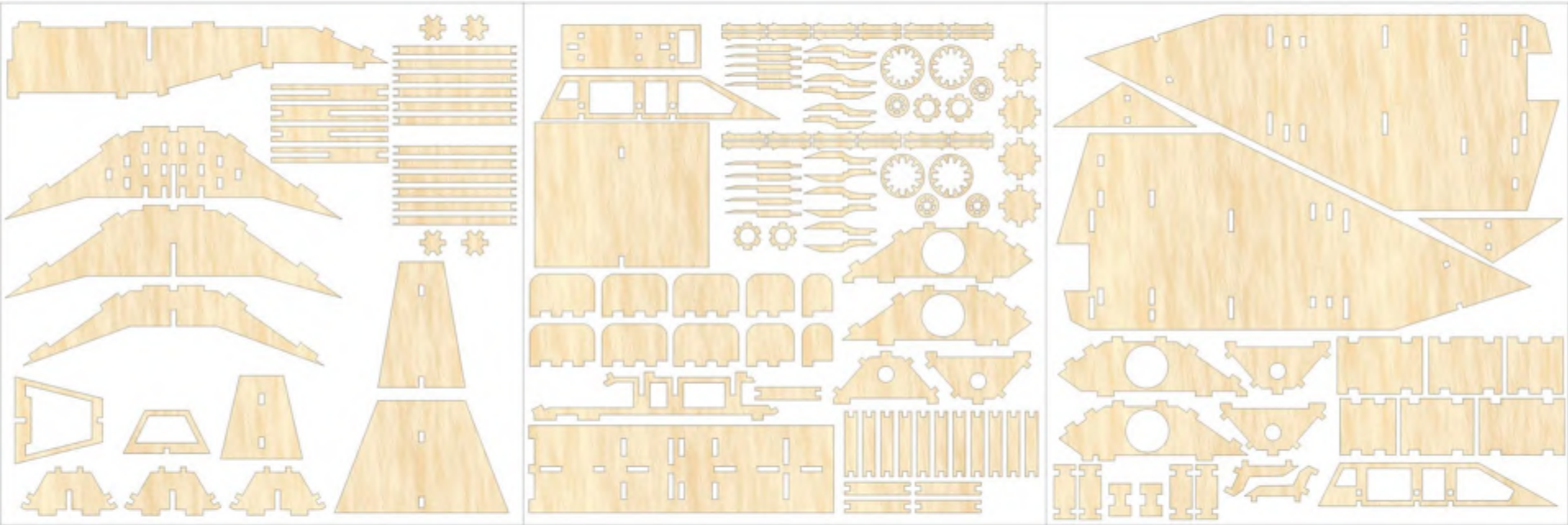

**PARTS LIST**



IT IS RECOMMENDED TO GO THROUGH ALL THE PAGES  
AND SEE EACH STEP BEFORE STARTING THE ASSEMBLY

**makeCNC**



**ASSEMBLY STEPS**



[www.makecnc.com](http://www.makecnc.com)

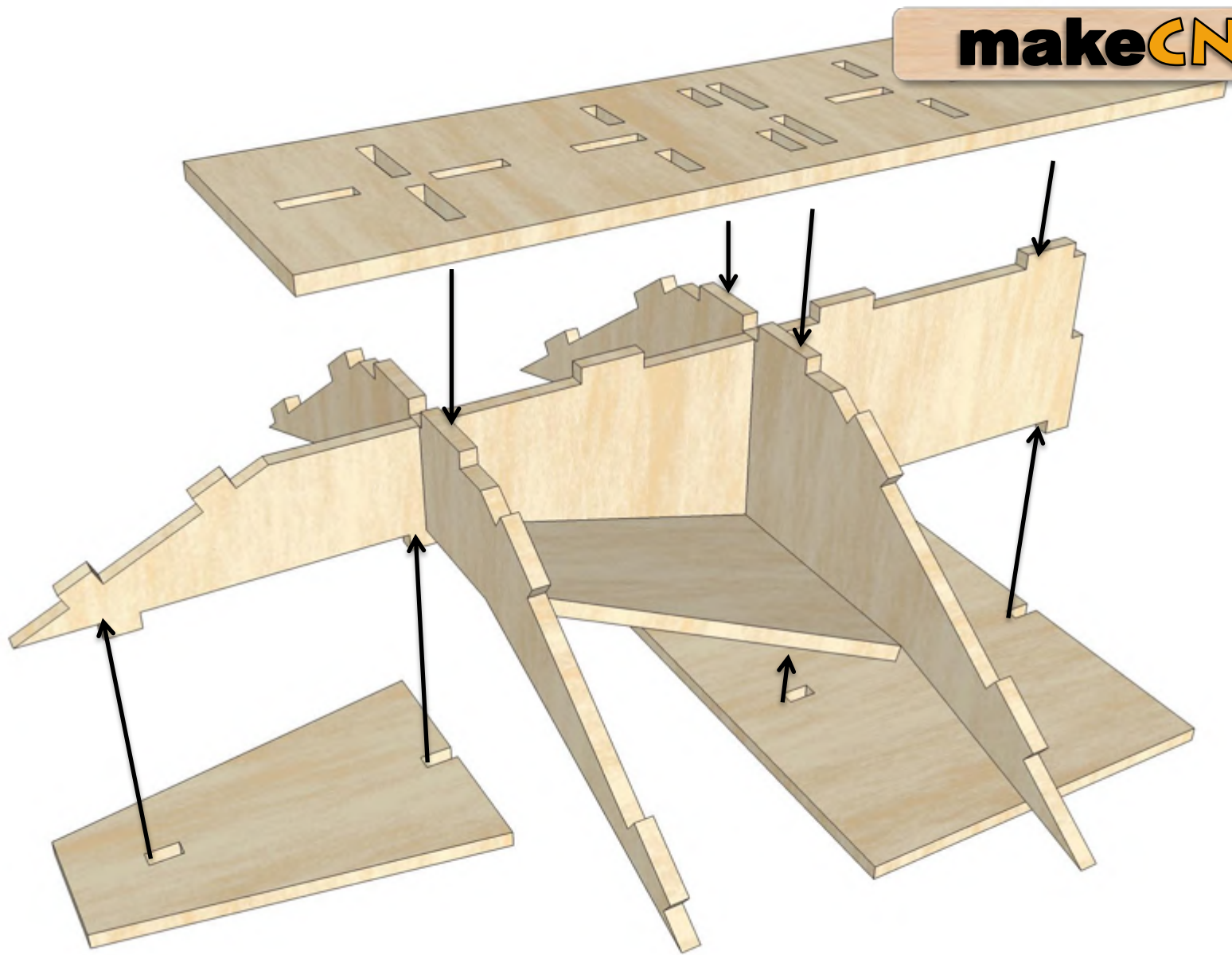

# ASSEMBLY STEPS



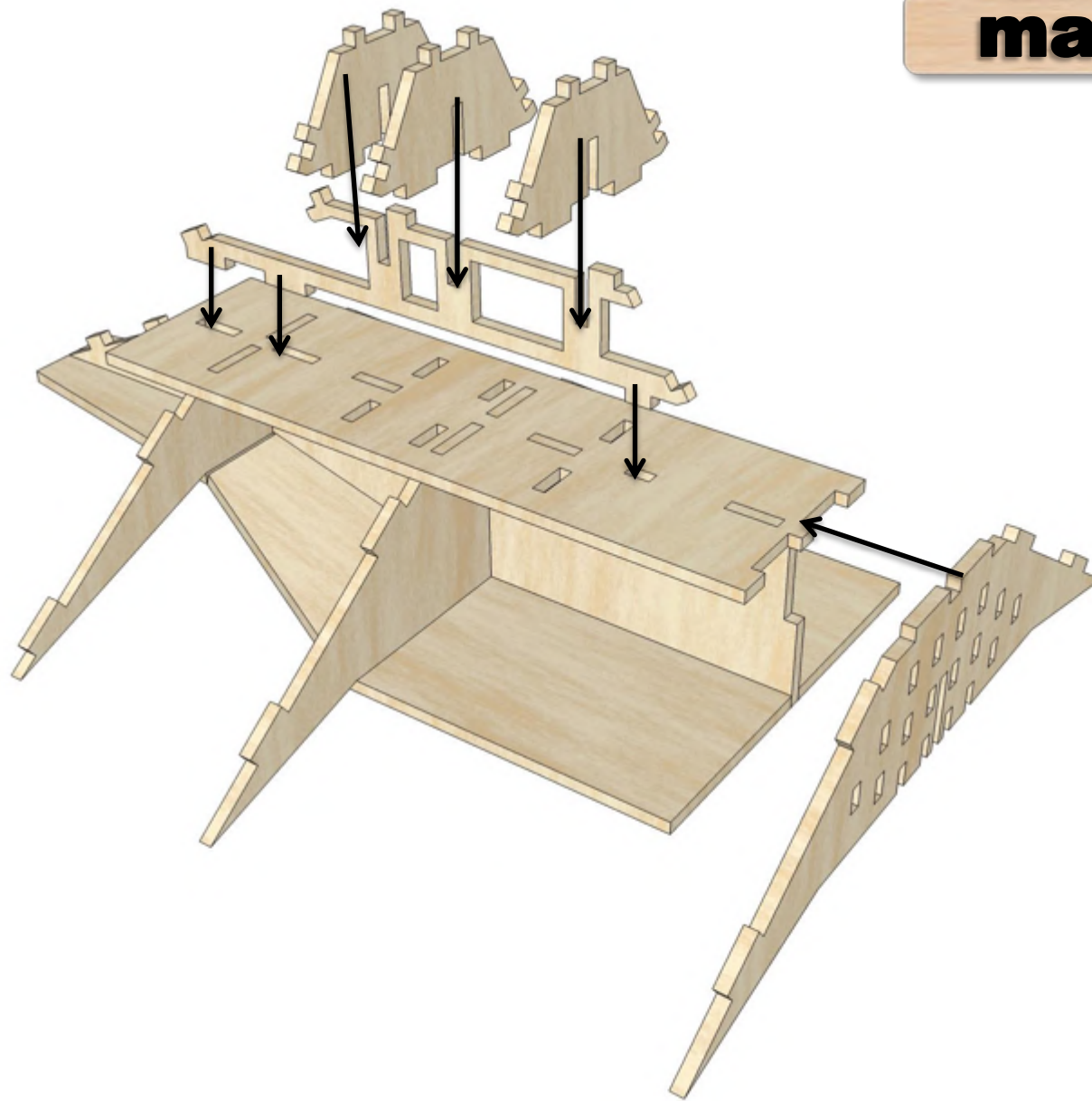

# ASSEMBLY STEPS



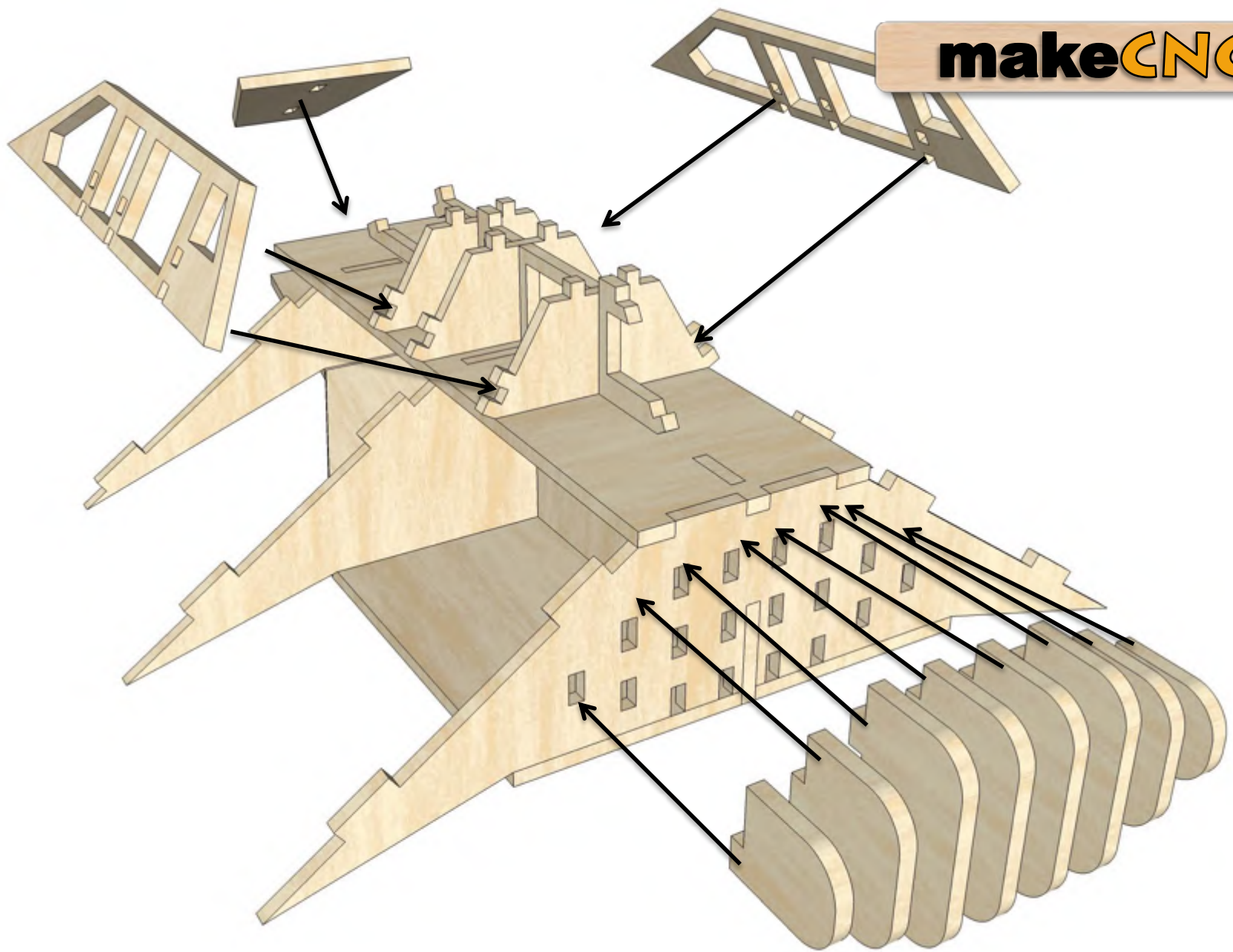

# ASSEMBLY STEPS



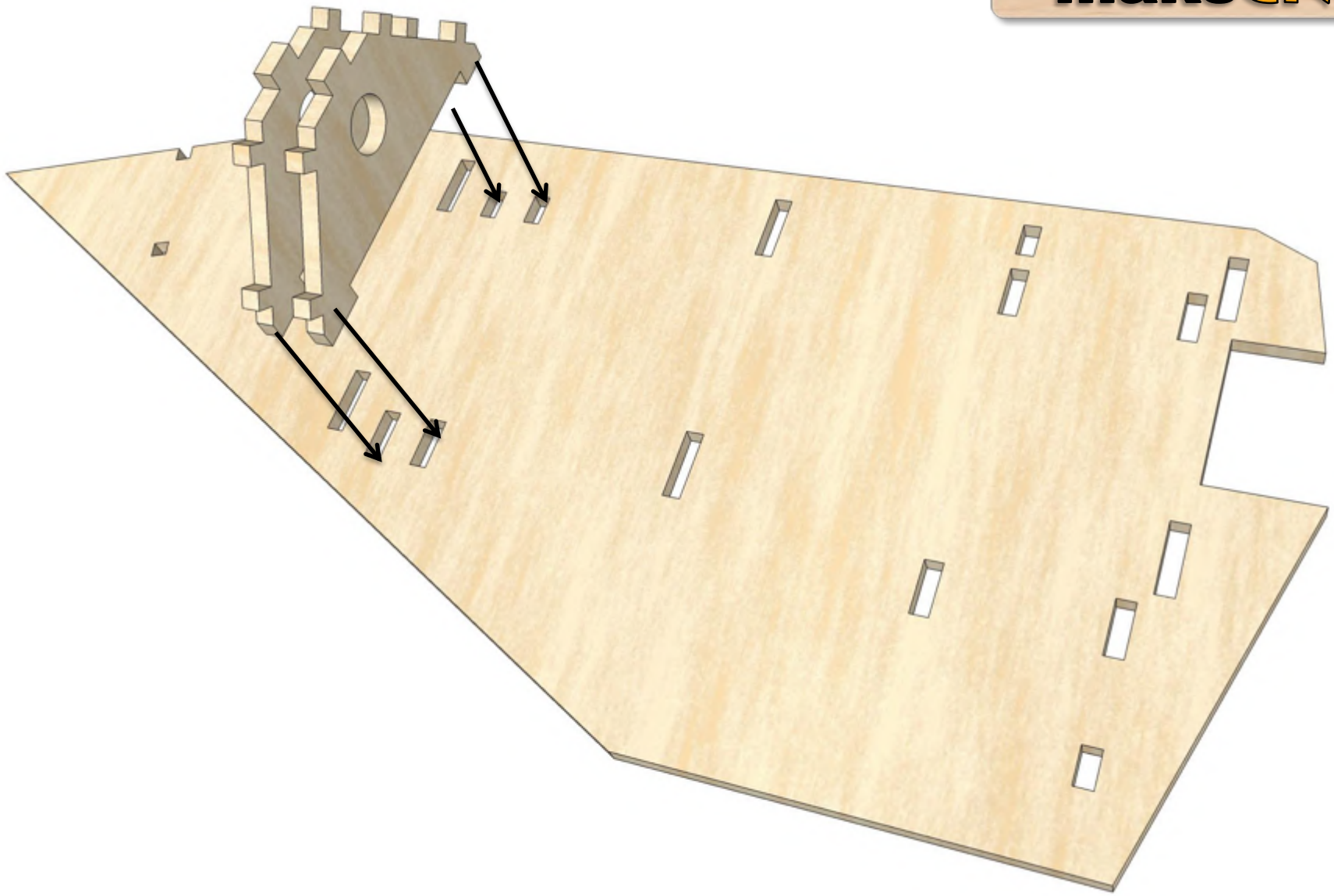

**ASSEMBLY STEPS**



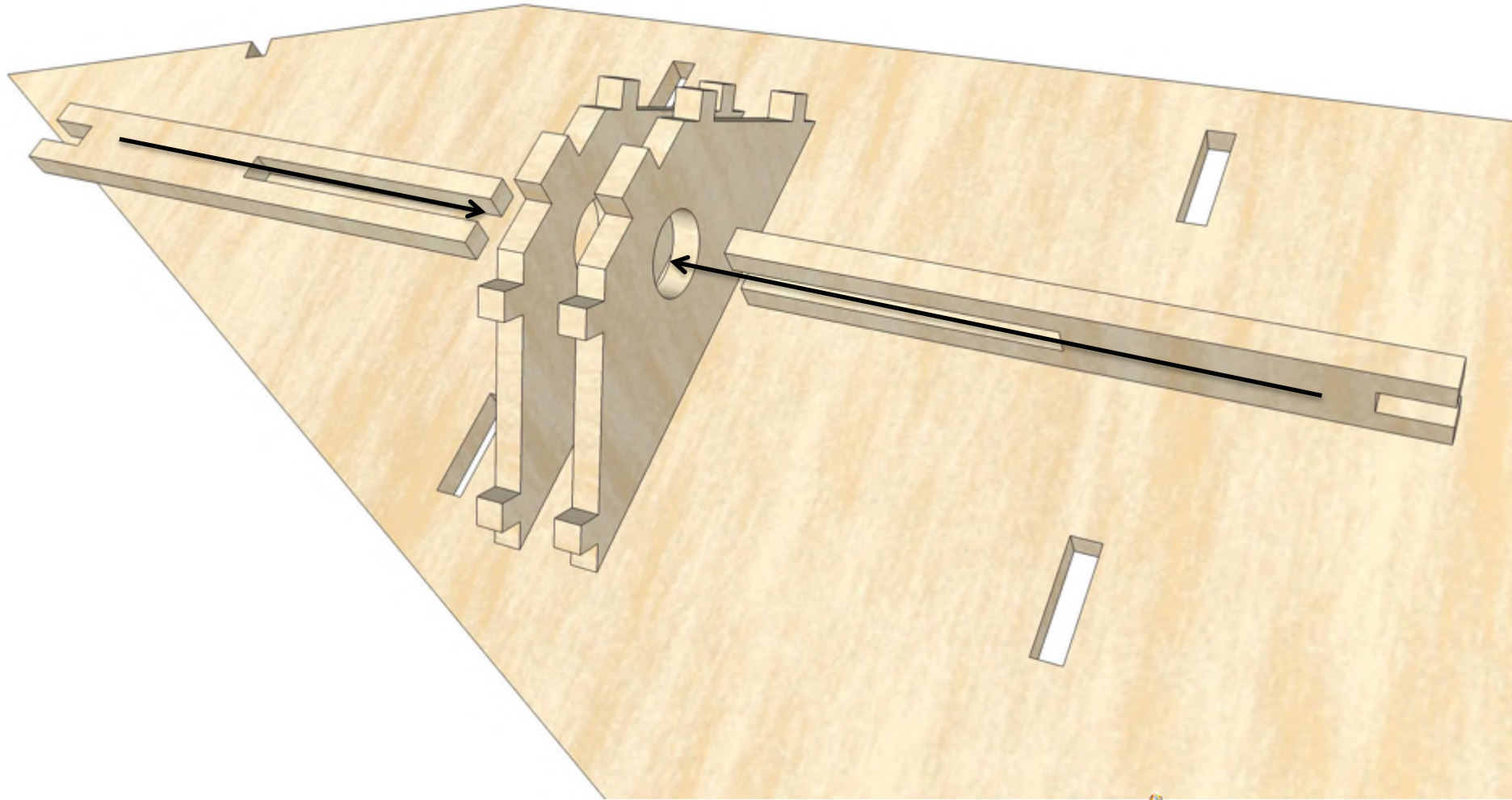

**ASSEMBLY STEPS**





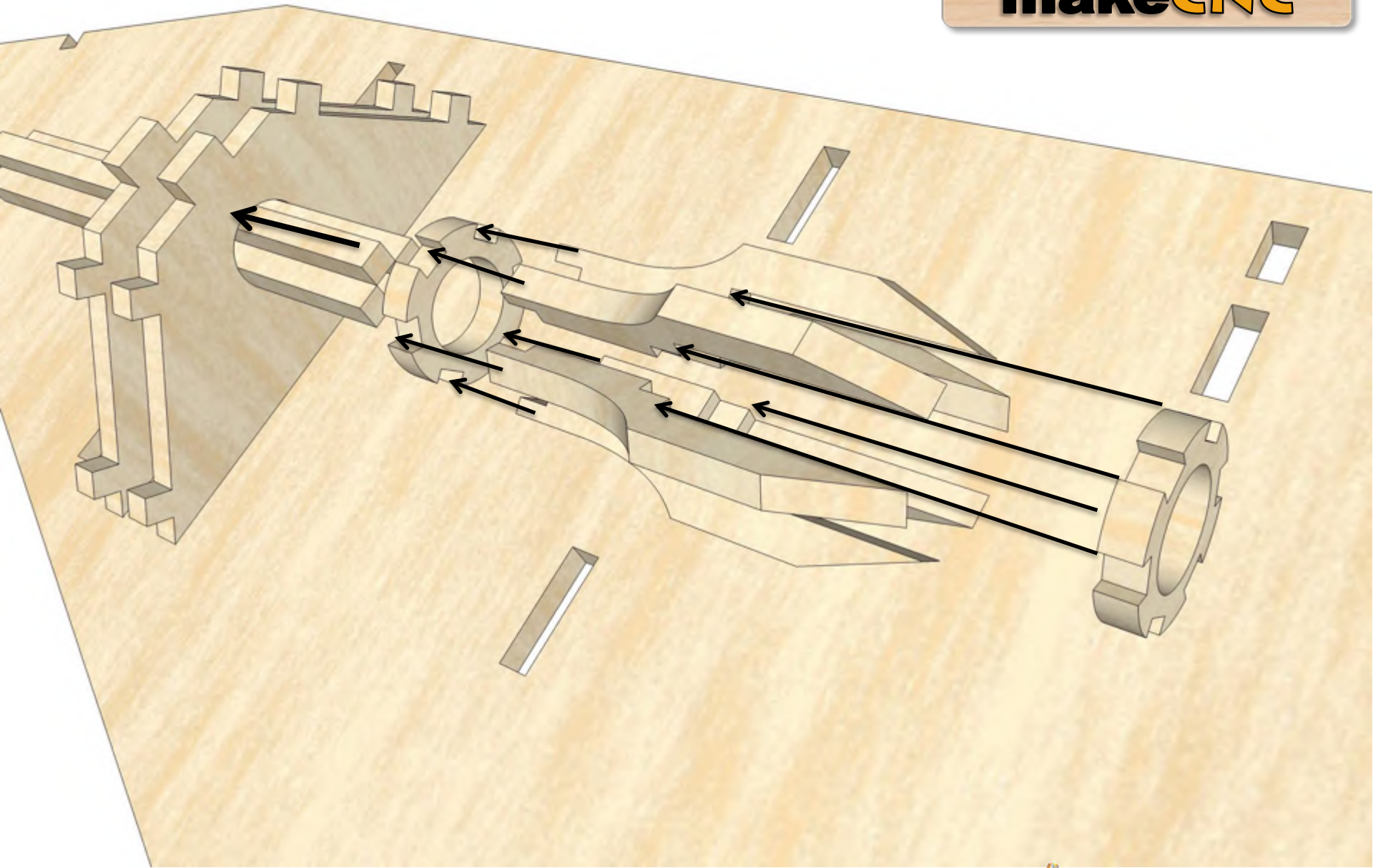

# ASSEMBLY STEPS



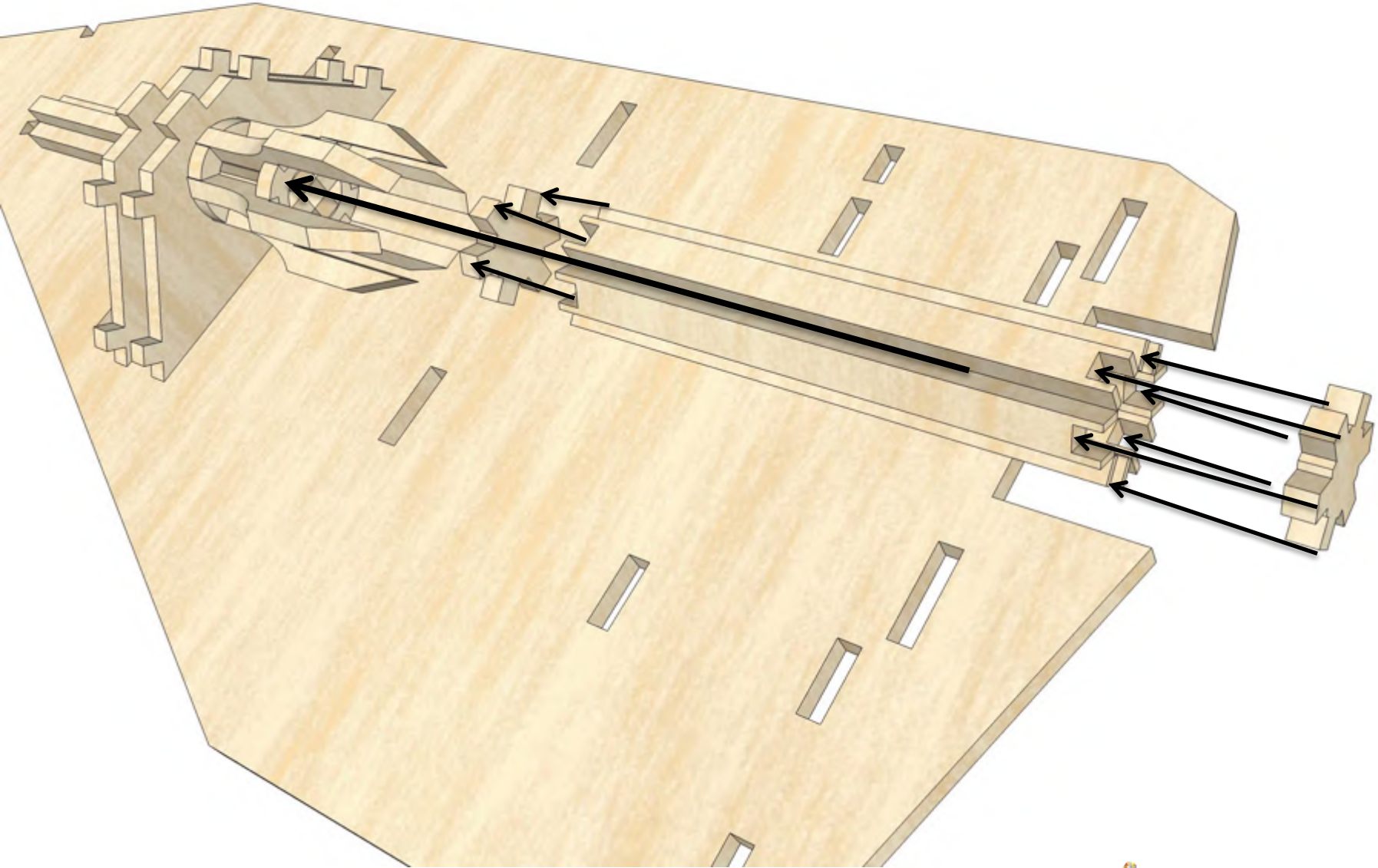

**ASSEMBLY STEPS**



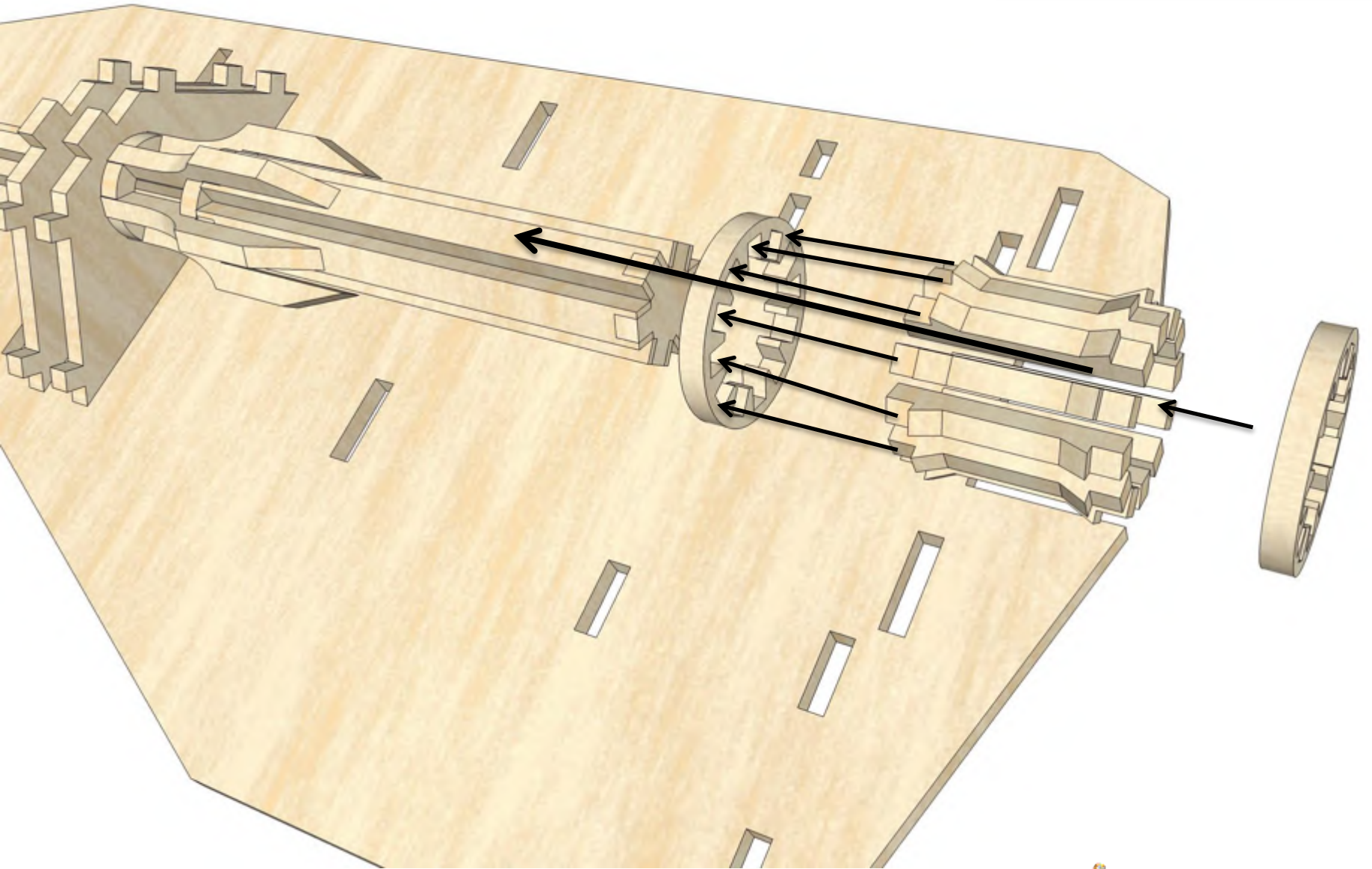

# ASSEMBLY STEPS



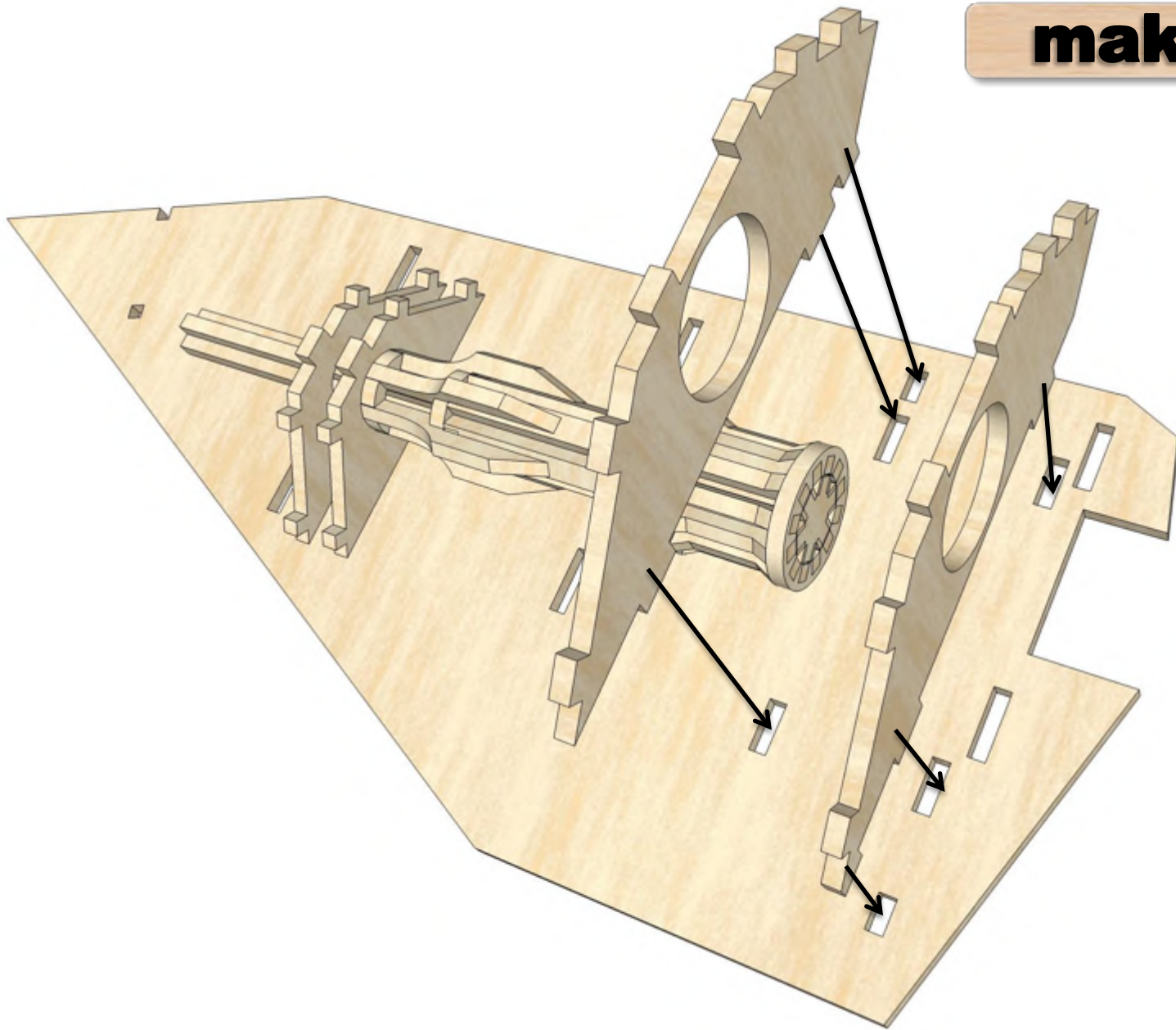

# ASSEMBLY STEPS



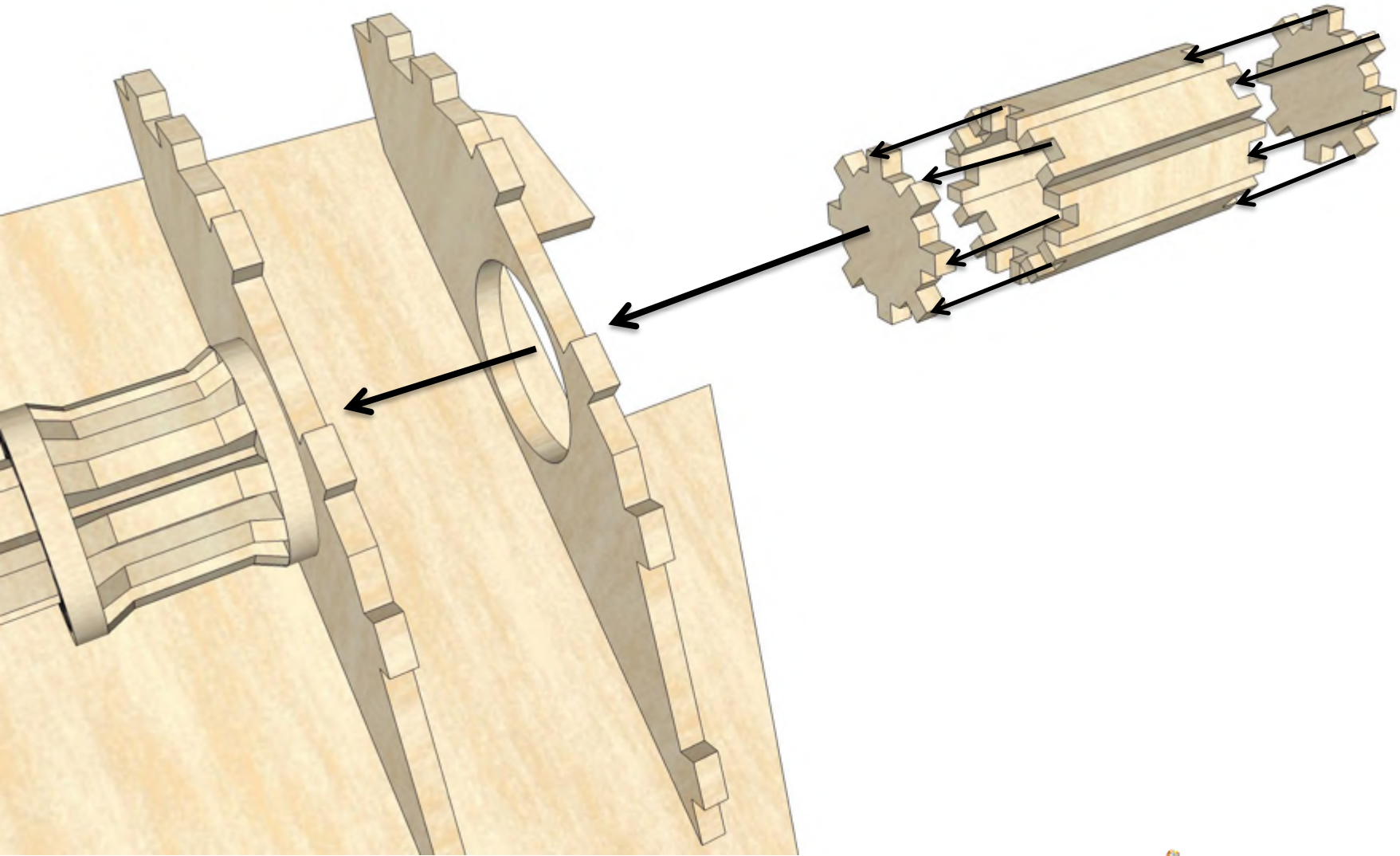

**ASSEMBLY STEPS**



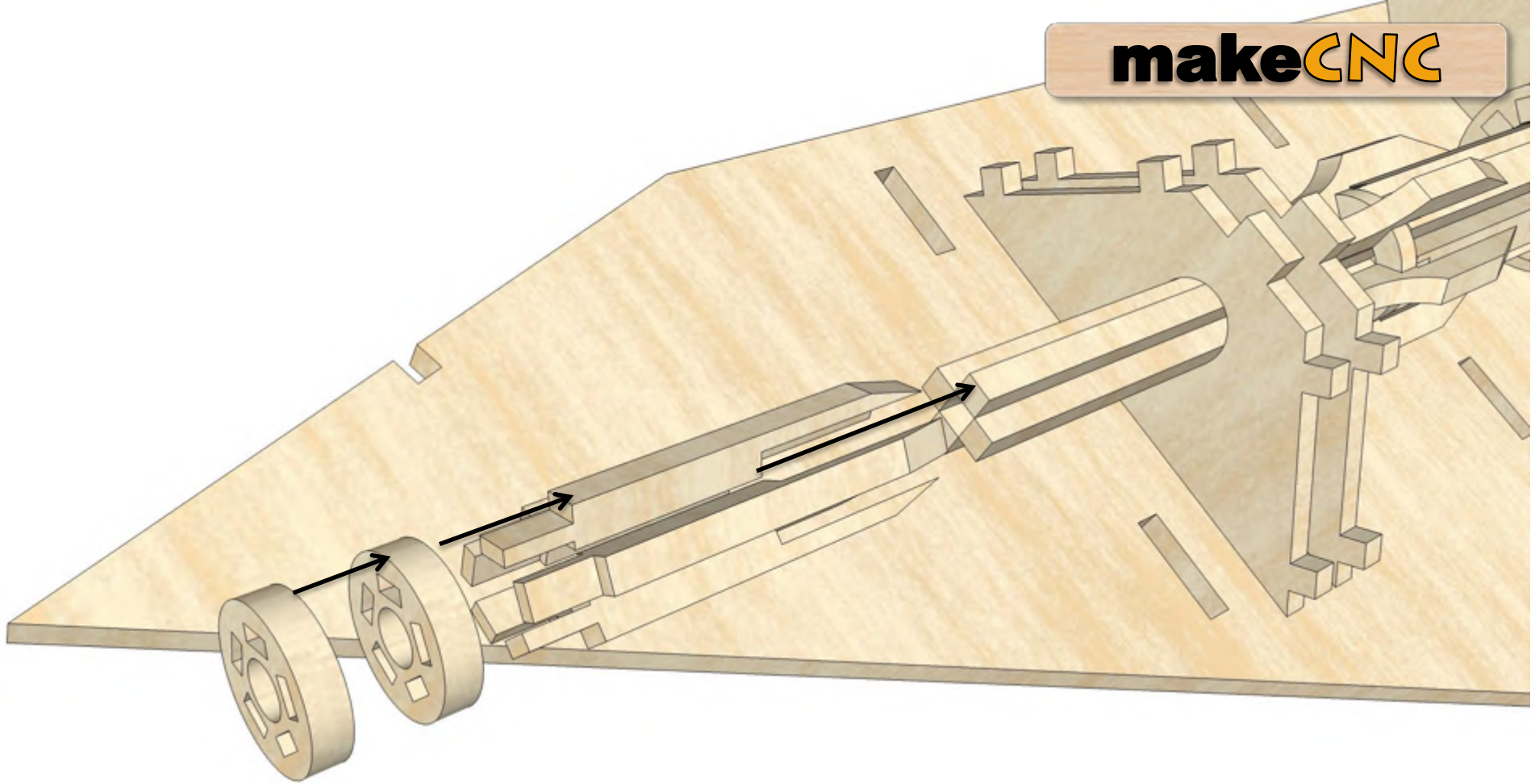

ASSEMBLY STEPS



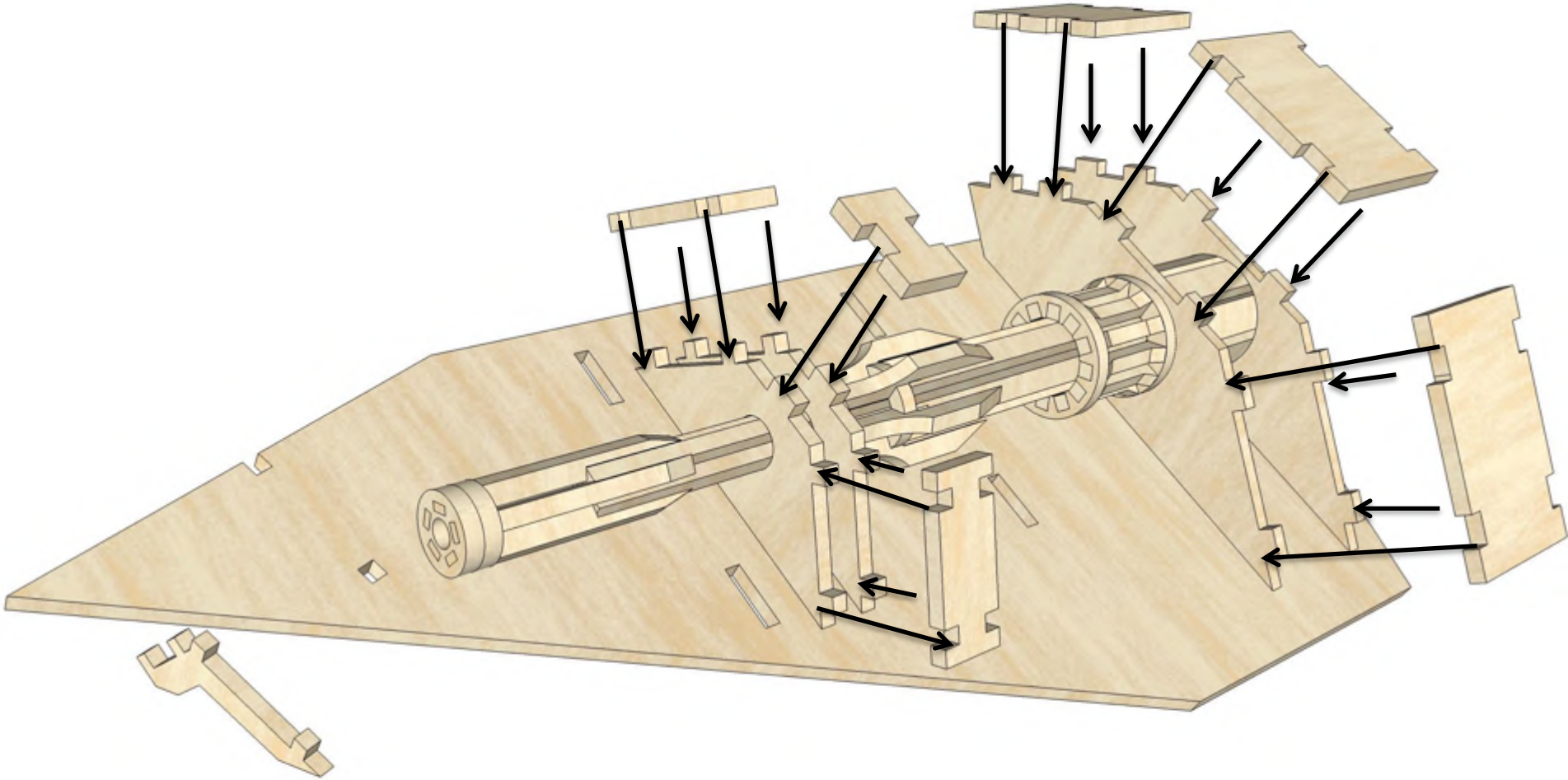

# ASSEMBLY STEPS



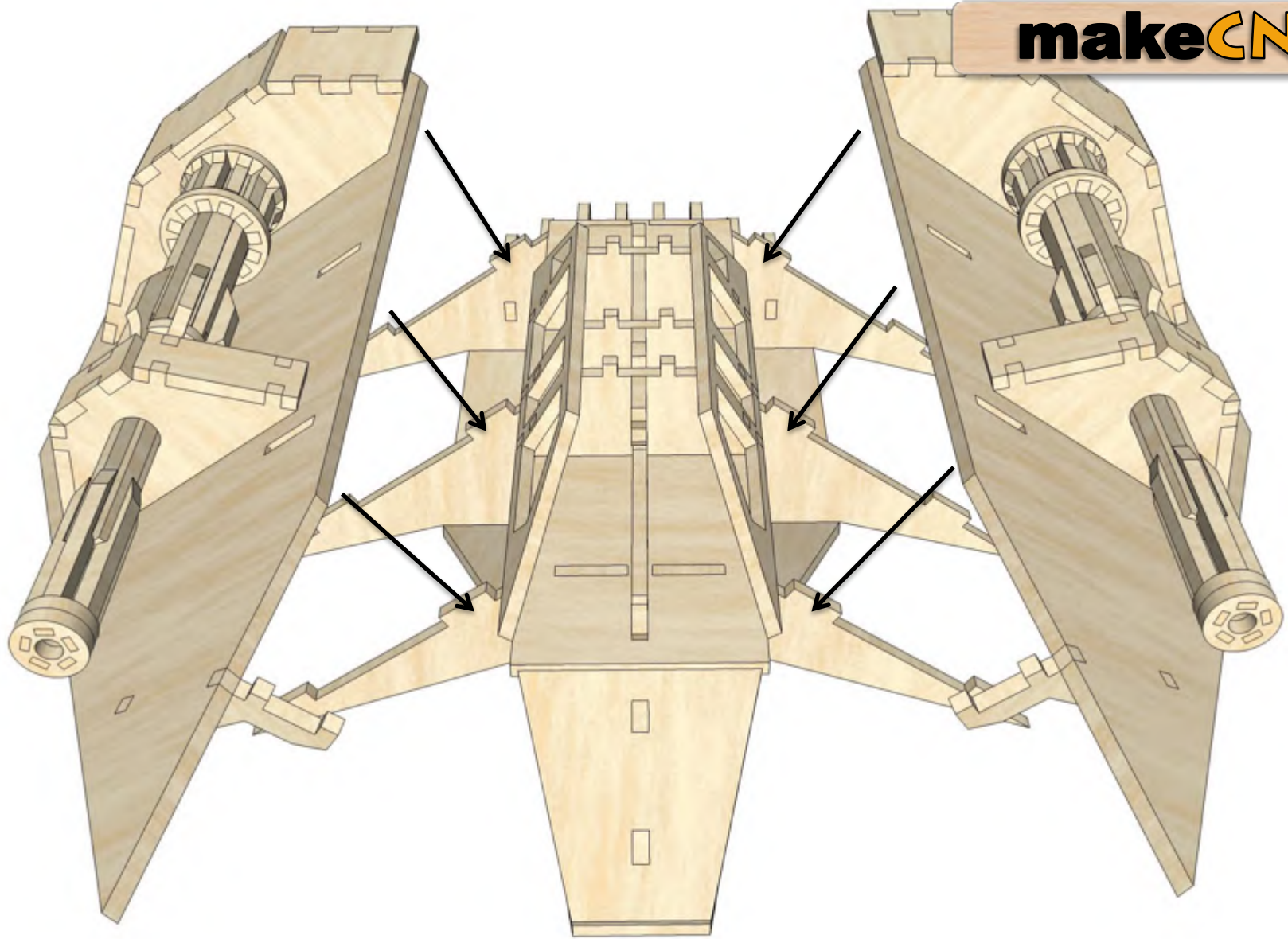

# ASSEMBLY STEPS





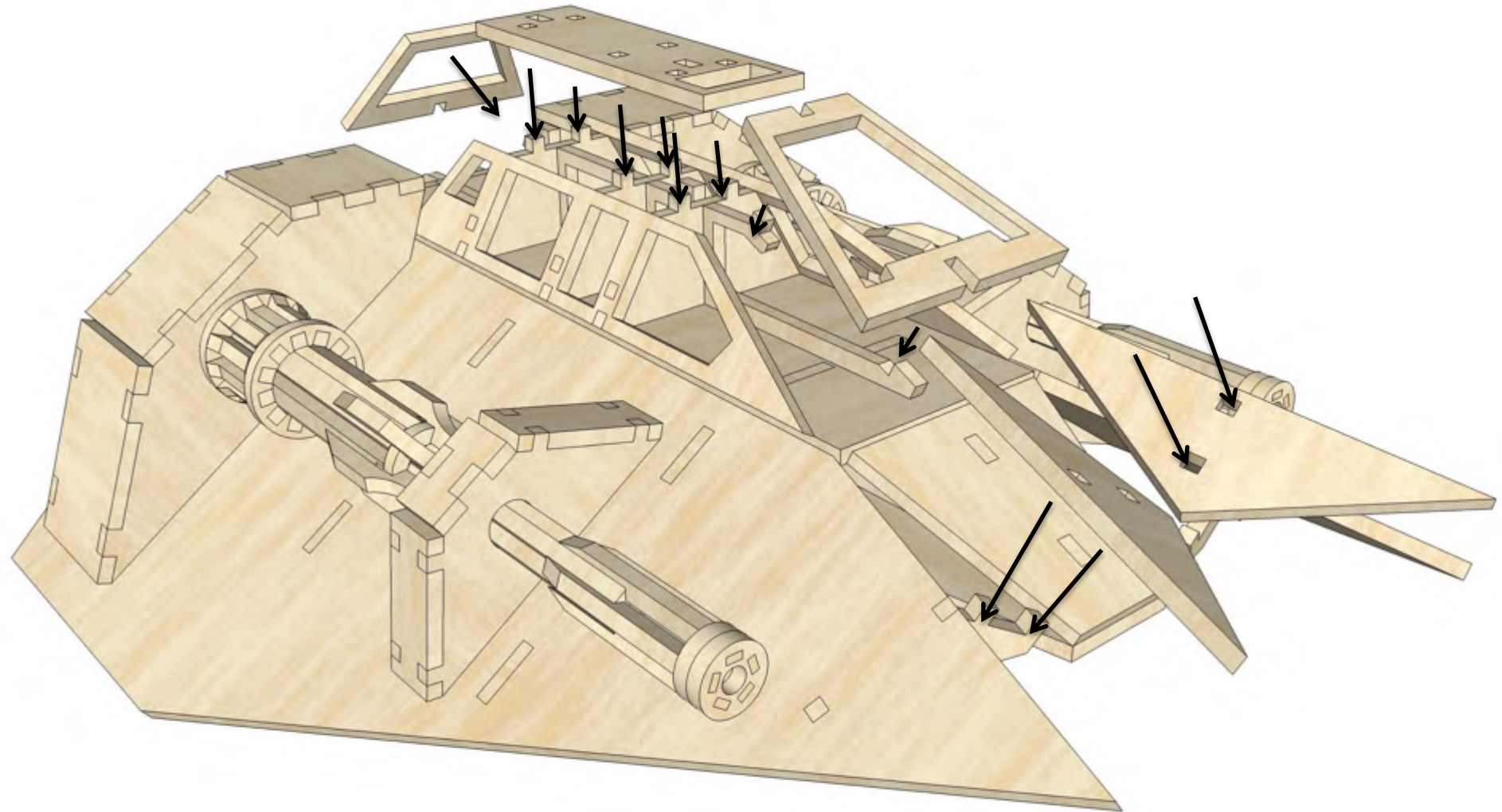

# ASSEMBLY STEPS



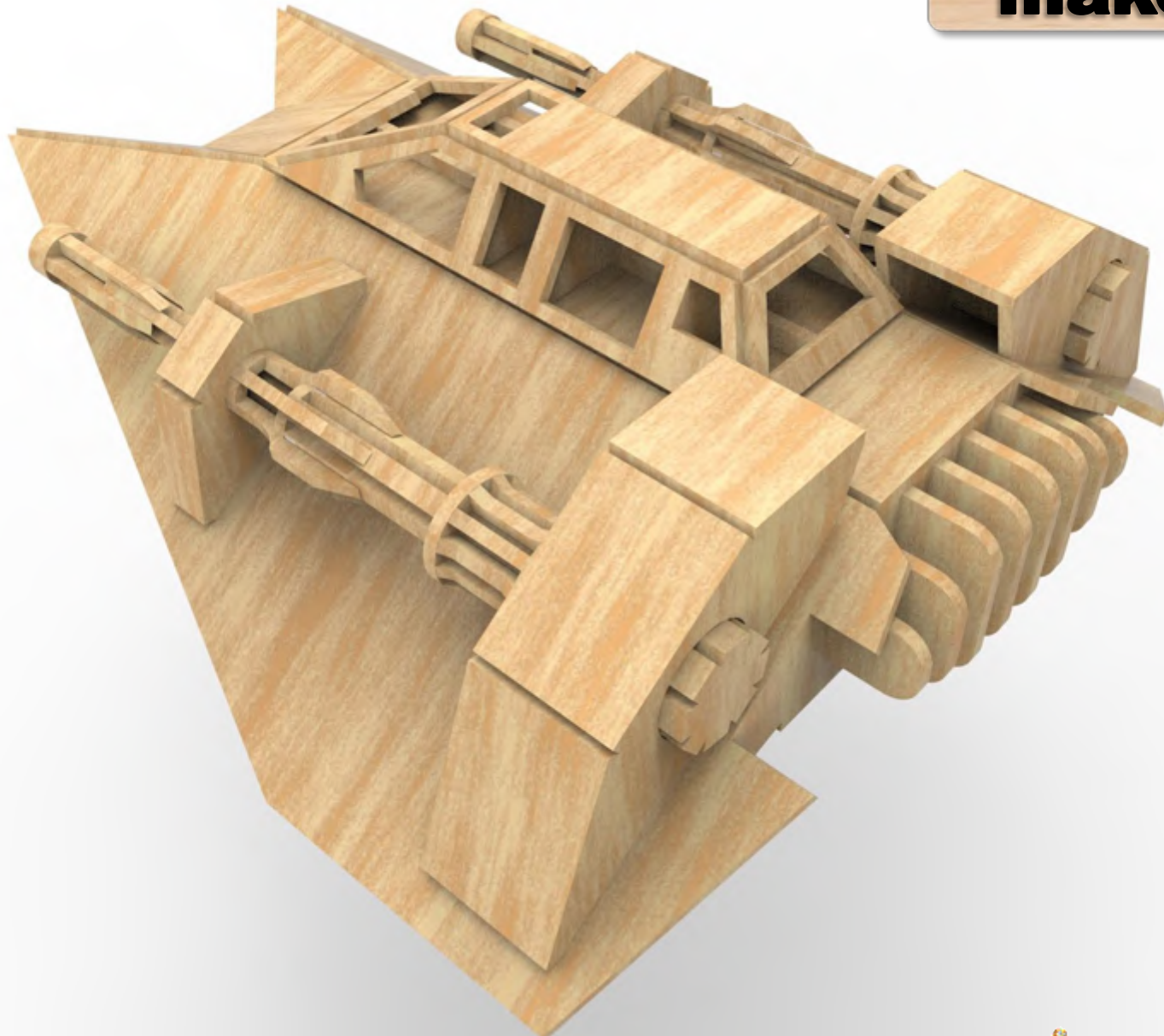

**COMPLETED**

