

makeCNC



**5TH WHEEL CAMPER
WITH INTERIOR**



makeCNC
Robotic Tools & other Machines

www.makecnc.com

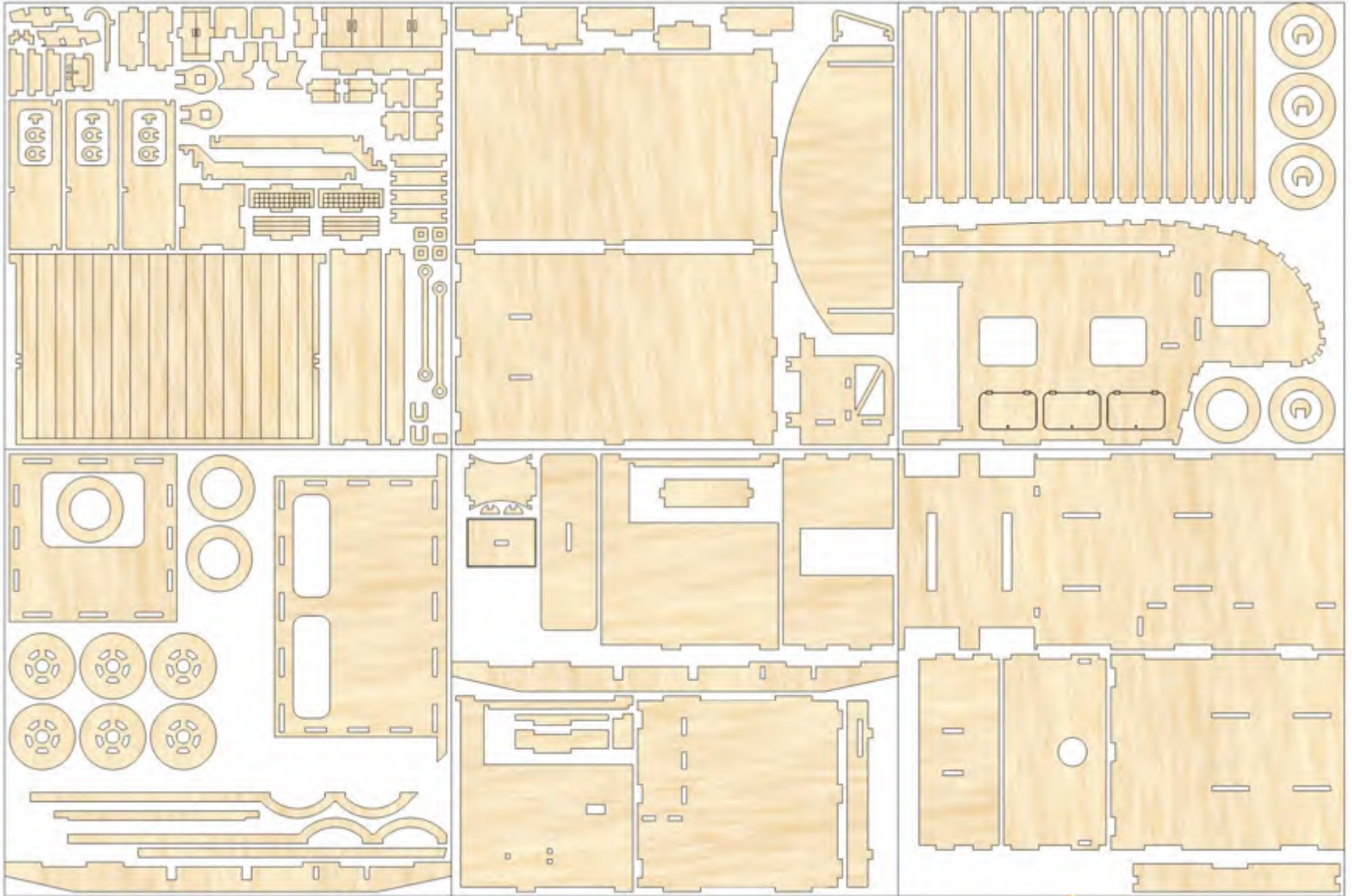

PARTS LIST





PARTS LIST



IT IS RECOMMENDED TO GO THROUGH ALL THE PAGES
AND SEE EACH STEP BEFORE STARTING THE ASSEMBLY

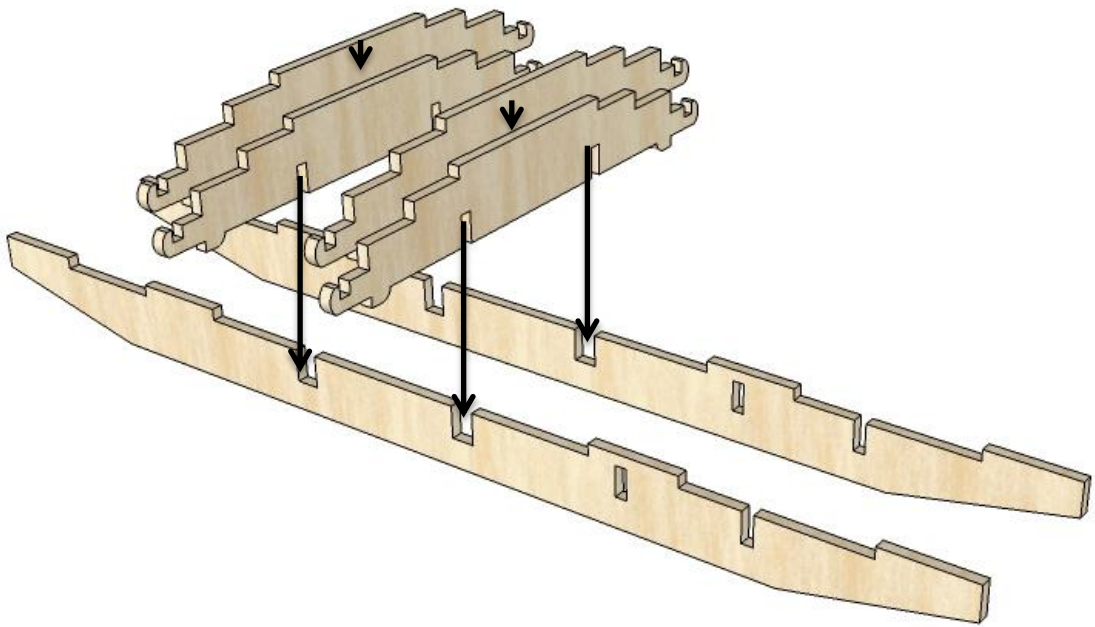

ASSEMBLY STEPS



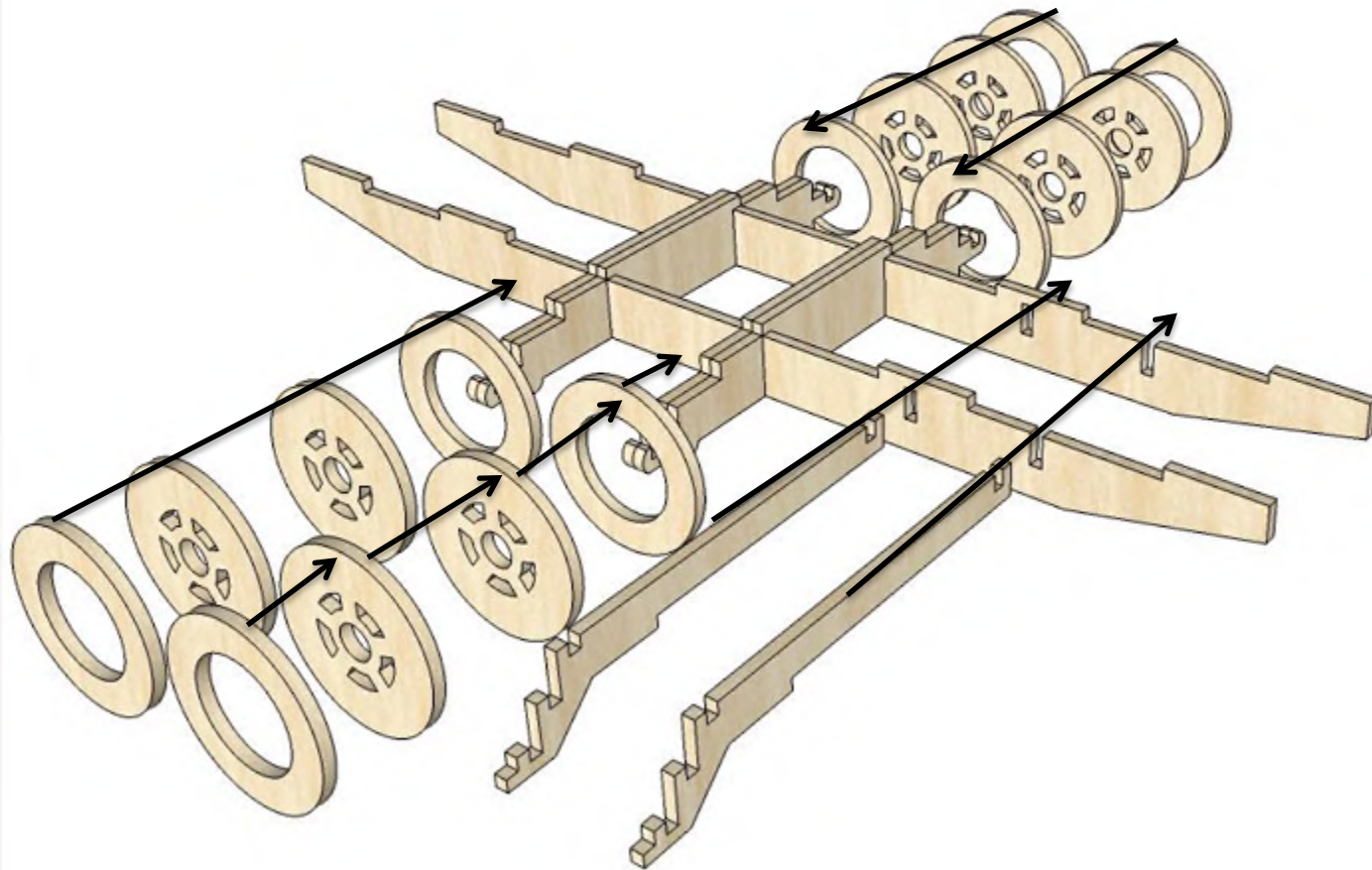

ASSEMBLY STEPS



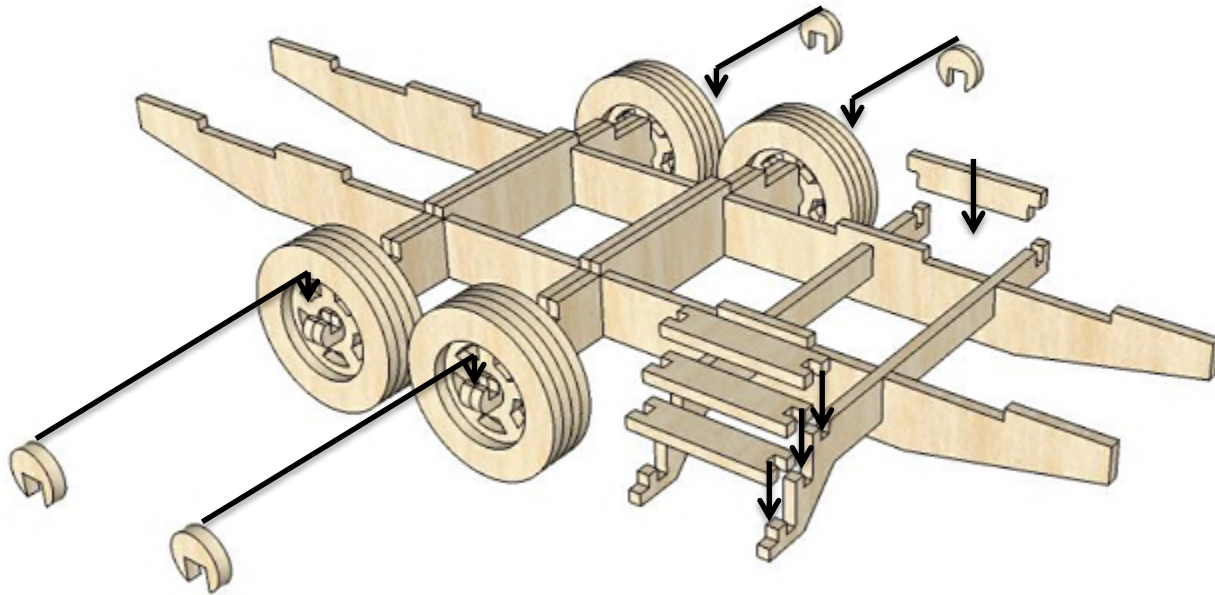

ASSEMBLY STEPS



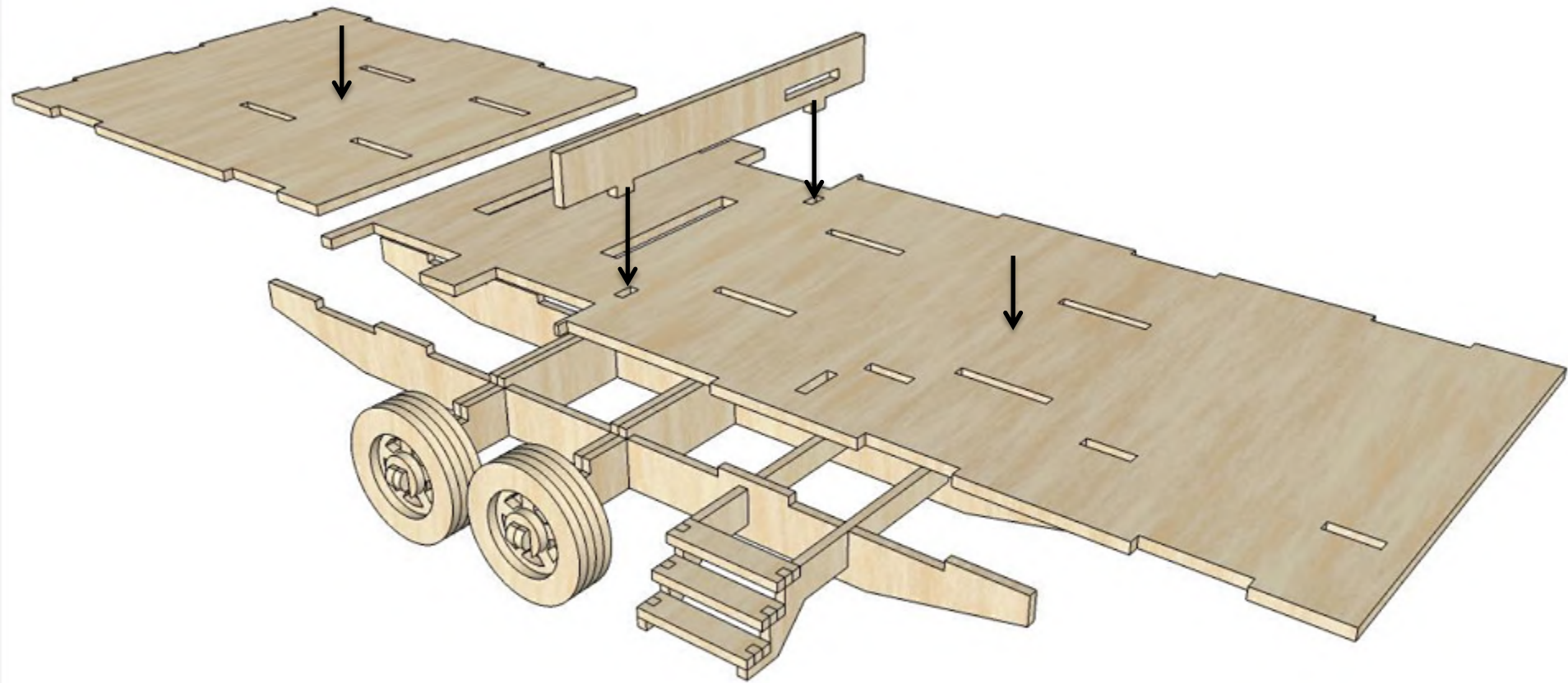

ASSEMBLY STEPS



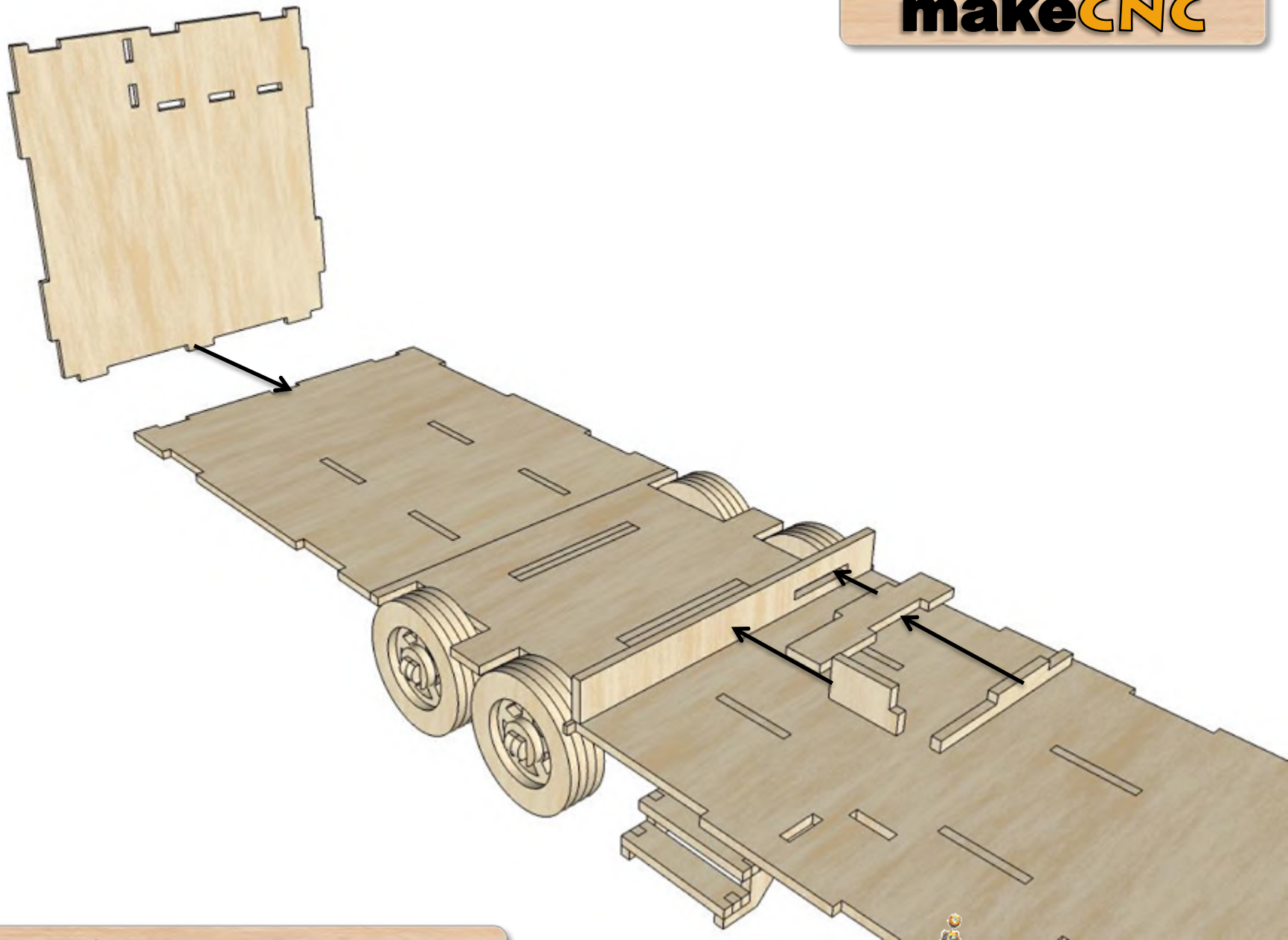

ASSEMBLY STEPS



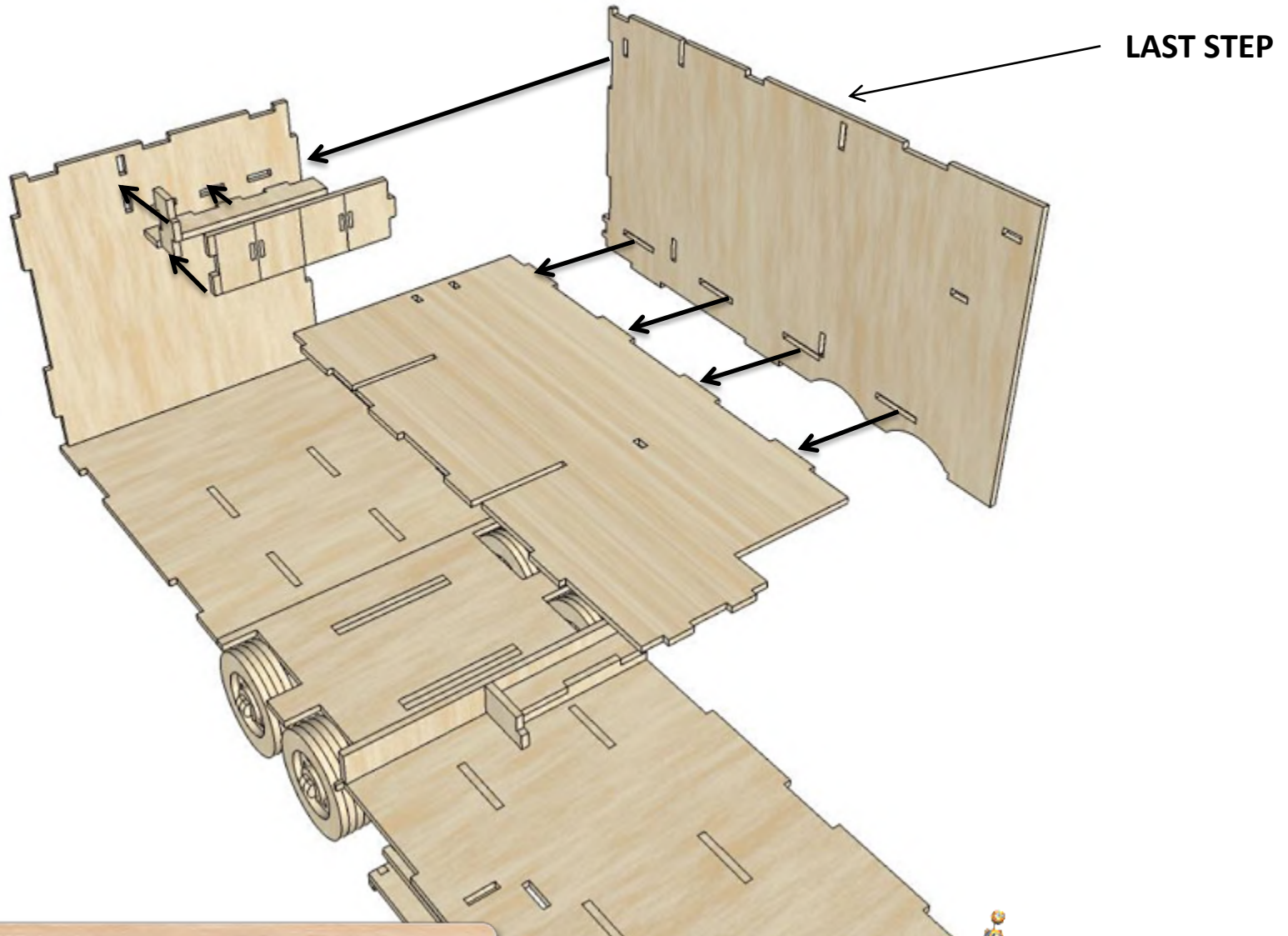

ASSEMBLY STEPS



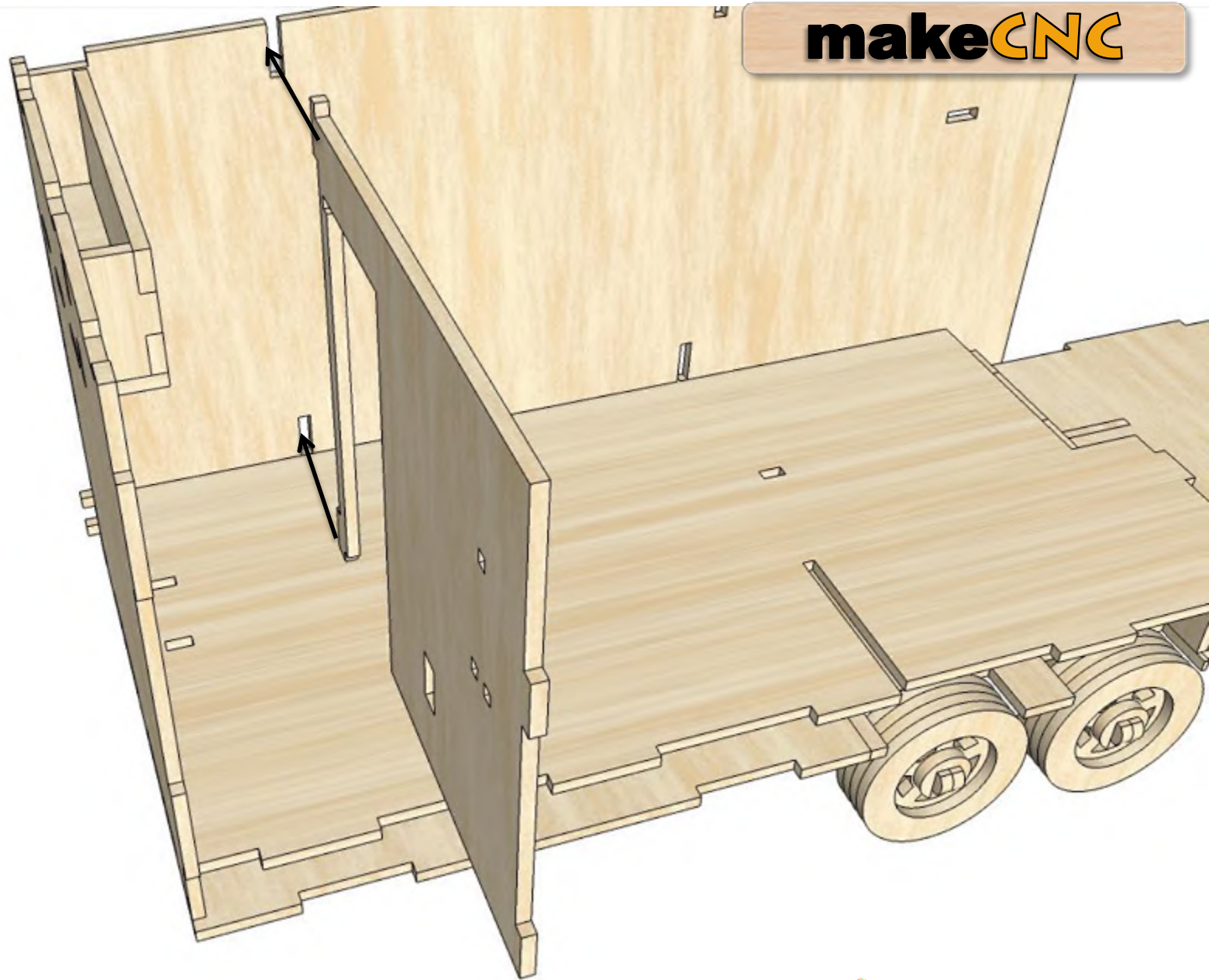

ASSEMBLY STEPS



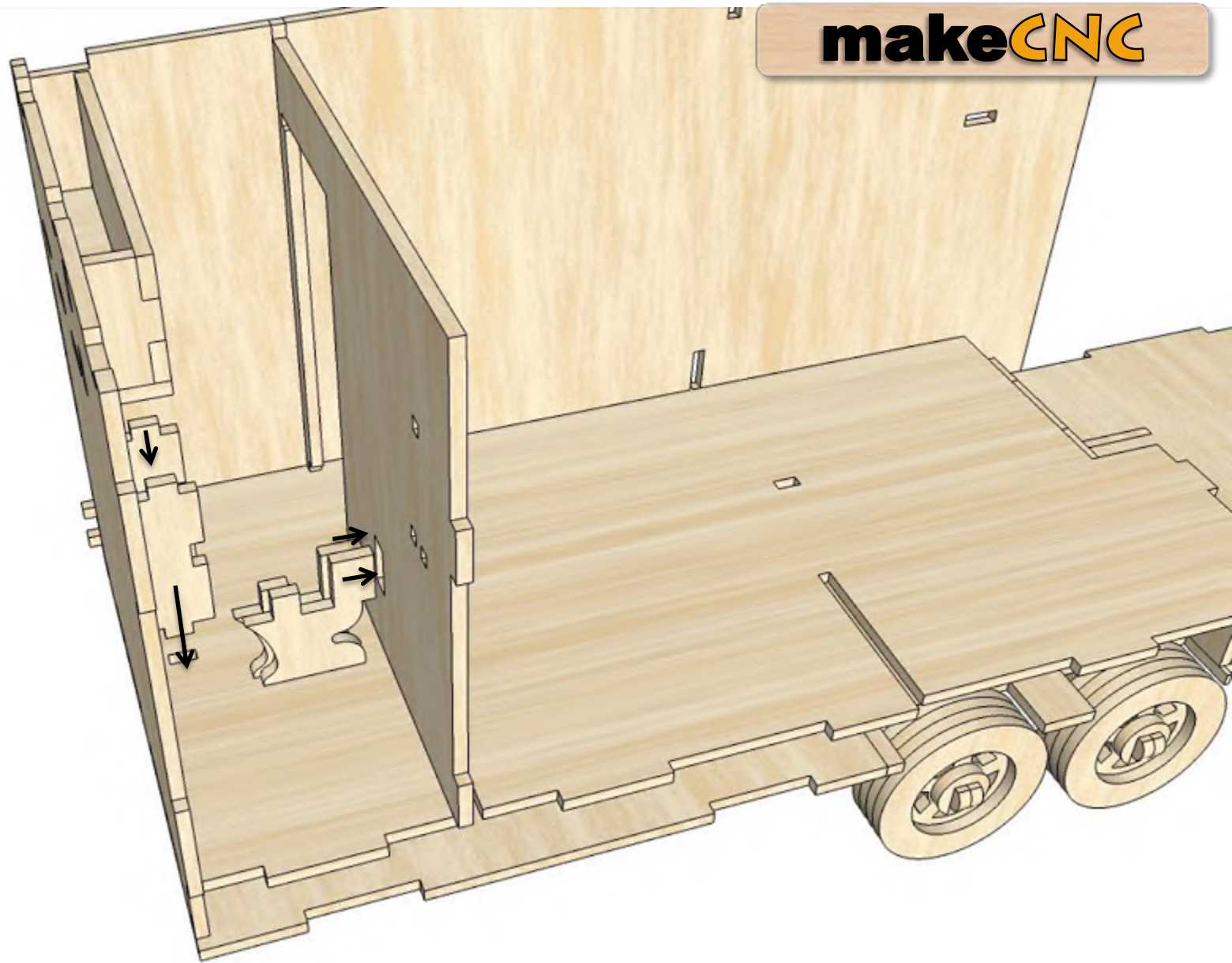

ASSEMBLY STEPS



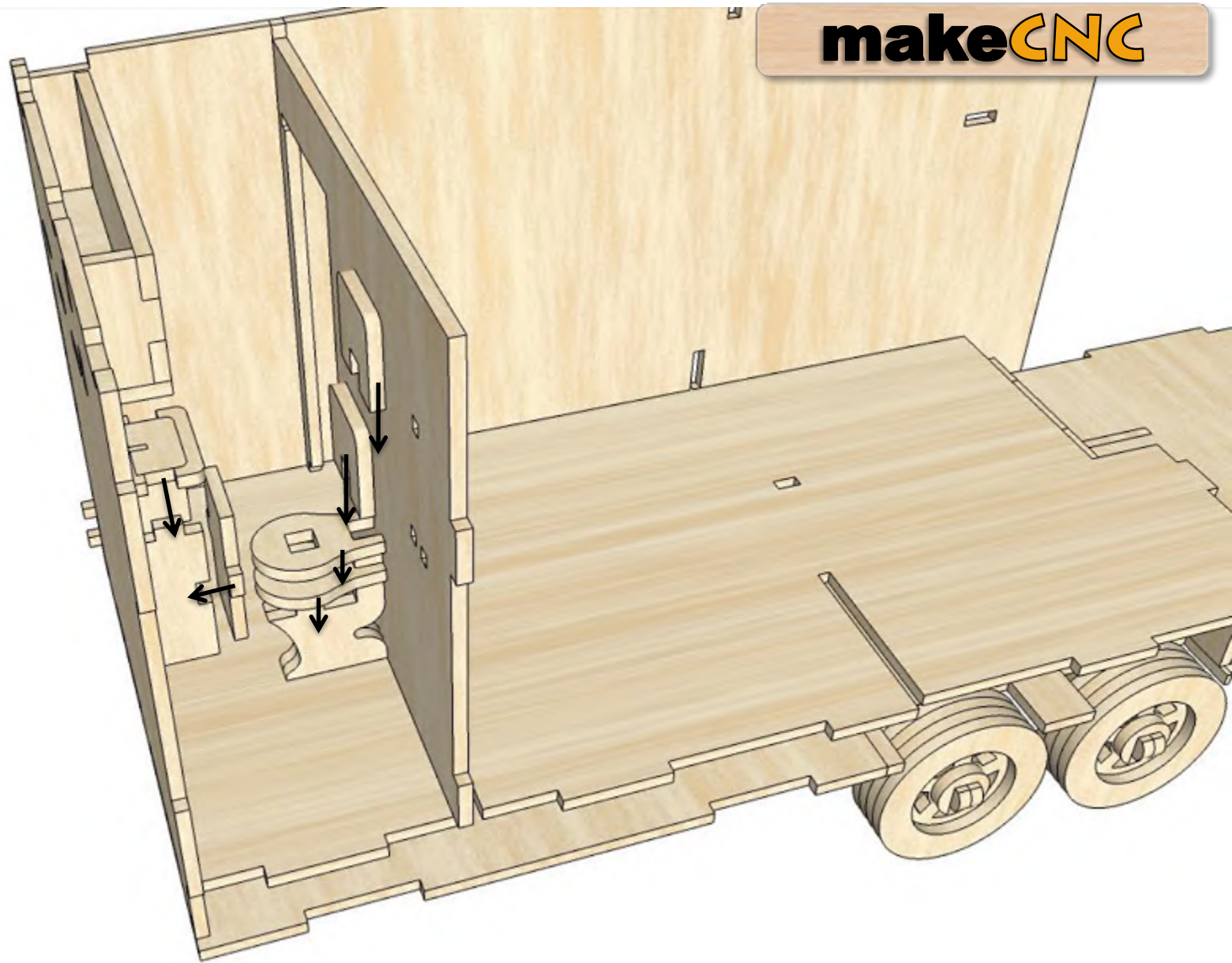

ASSEMBLY STEPS



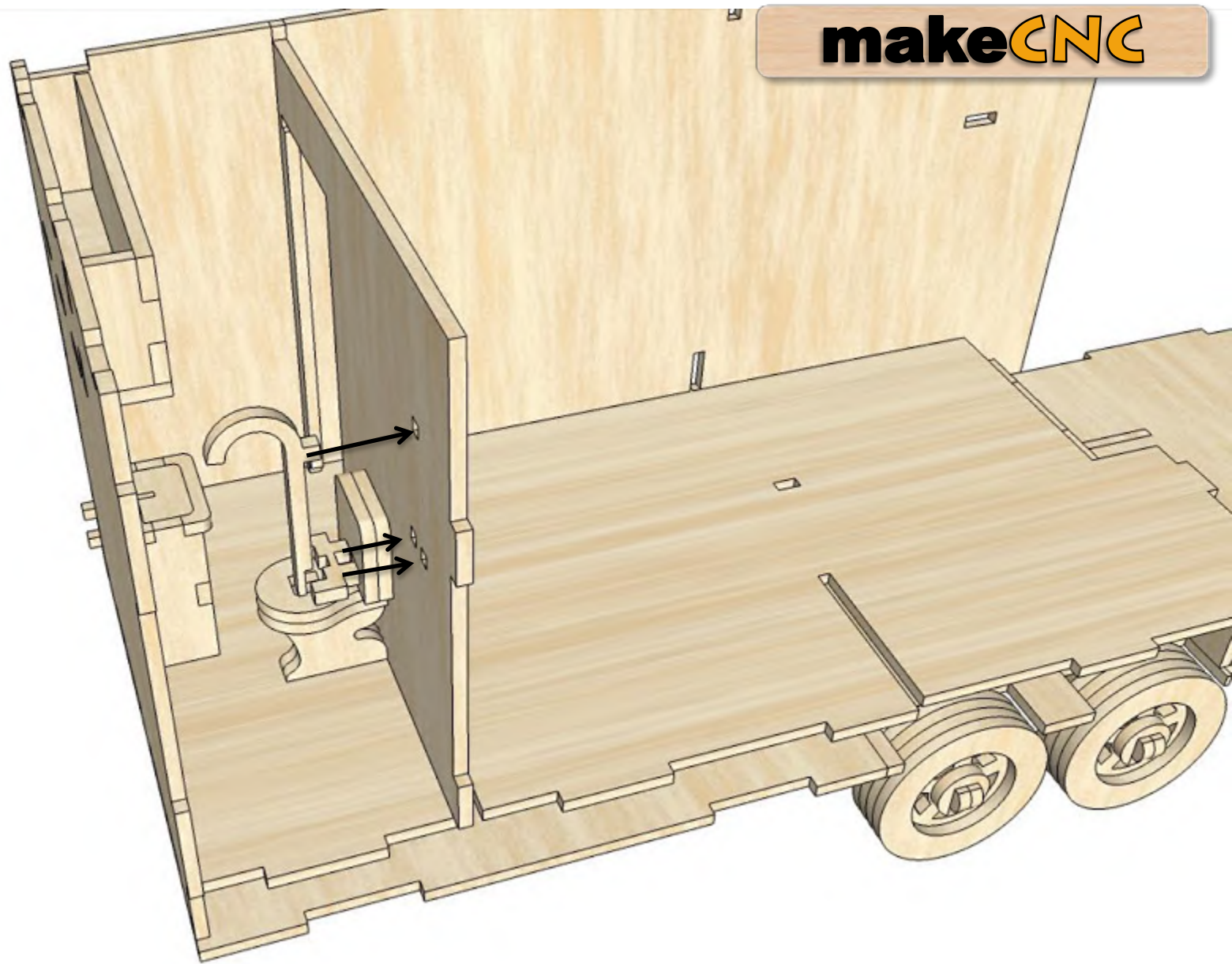

ASSEMBLY STEPS



YOU WILL PLACE THE HANDLE
AFTER THE DOOR IS IN PLACE
THE HANDLE SHOULD BE INSIDE
THE BATHROOM

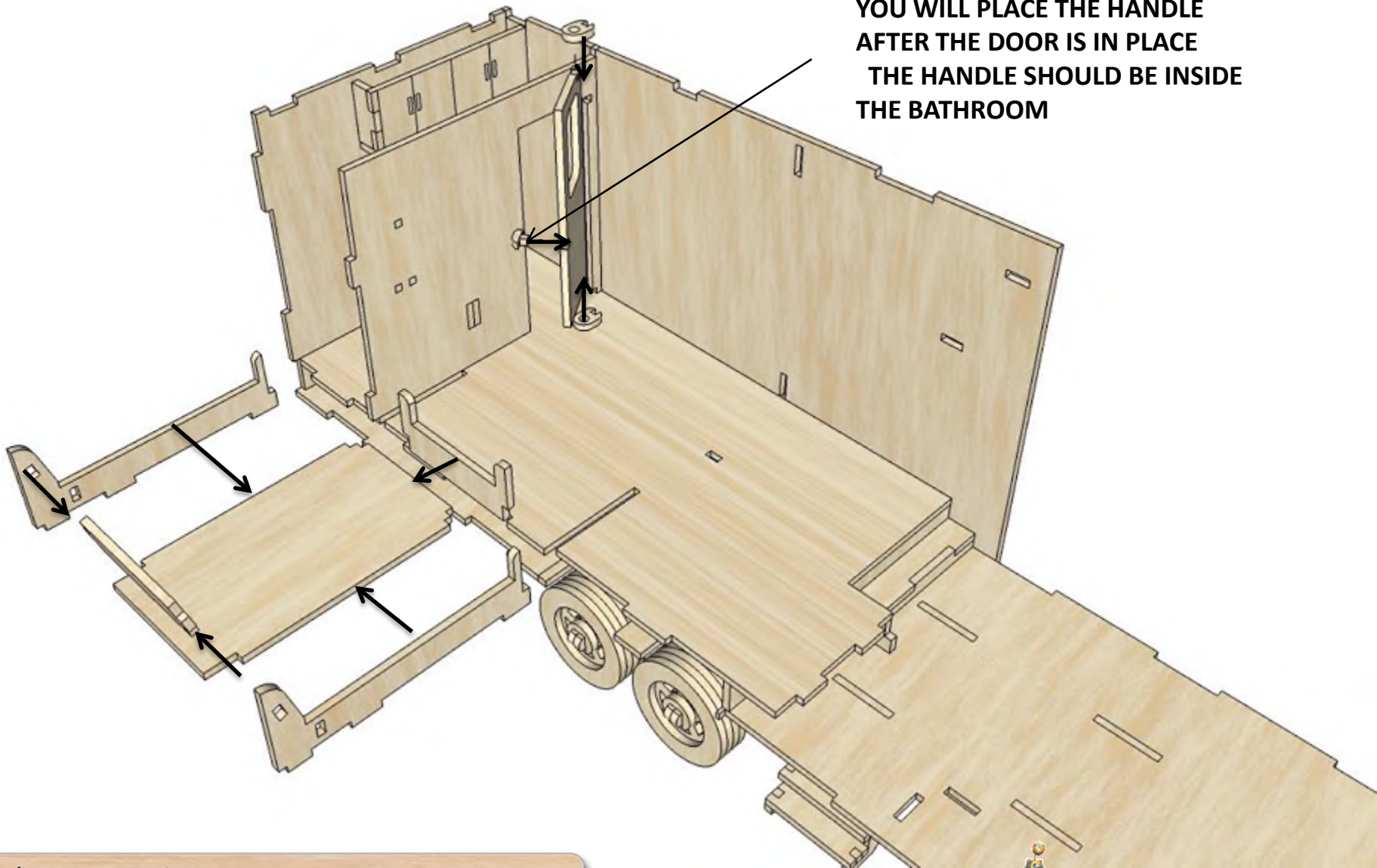

ASSEMBLY STEPS



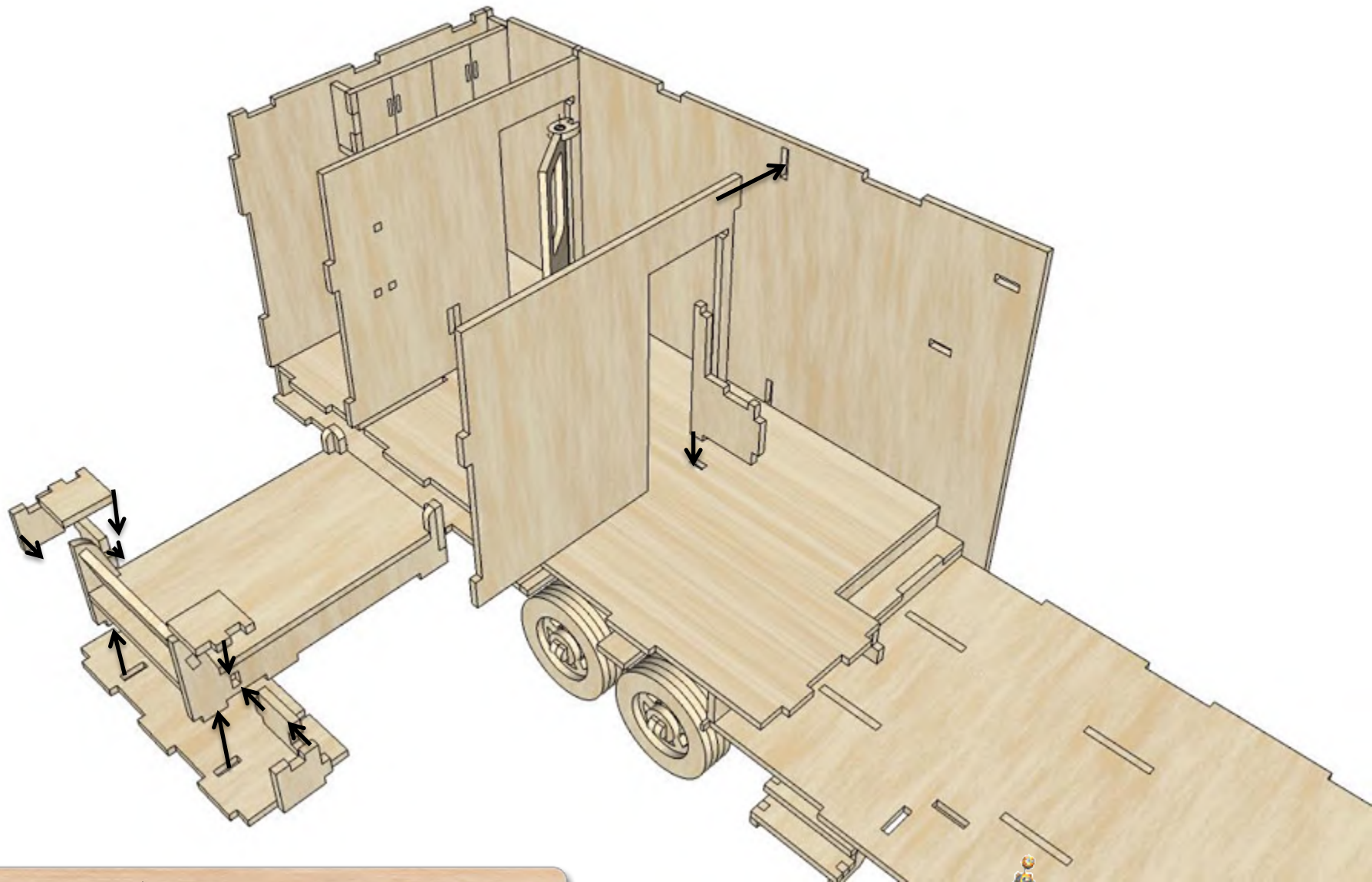

ASSEMBLY STEPS



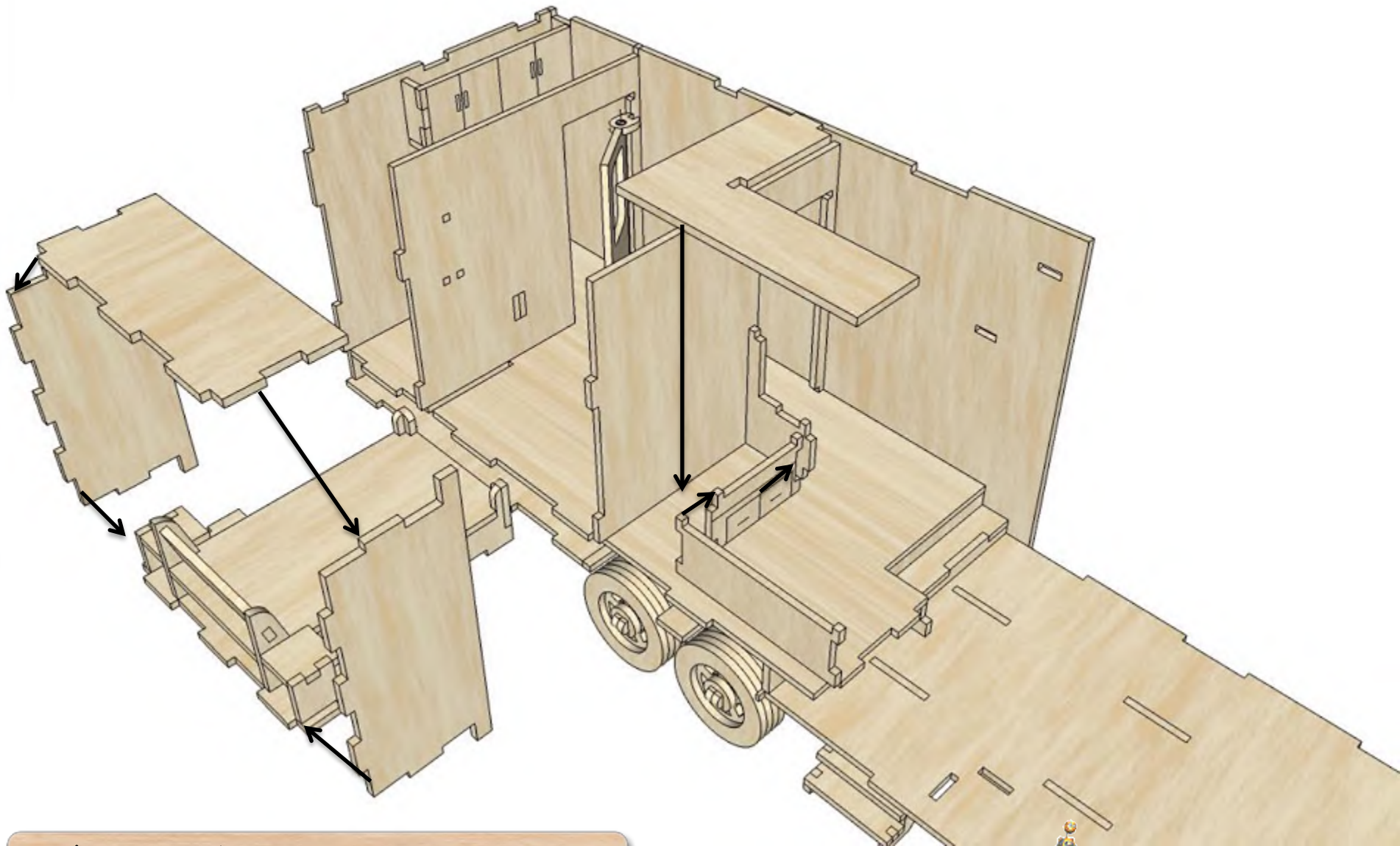

ASSEMBLY STEPS



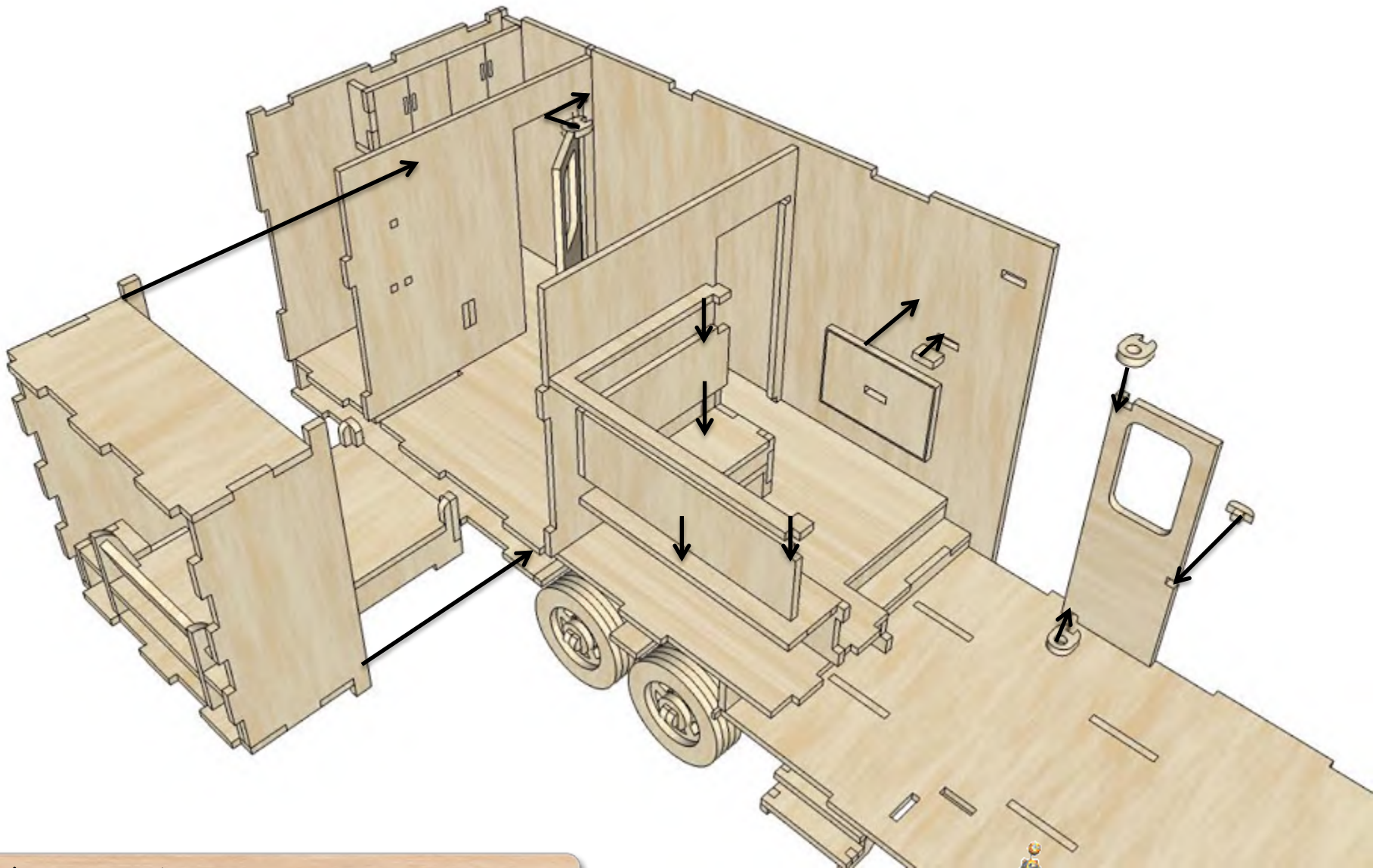

ASSEMBLY STEPS



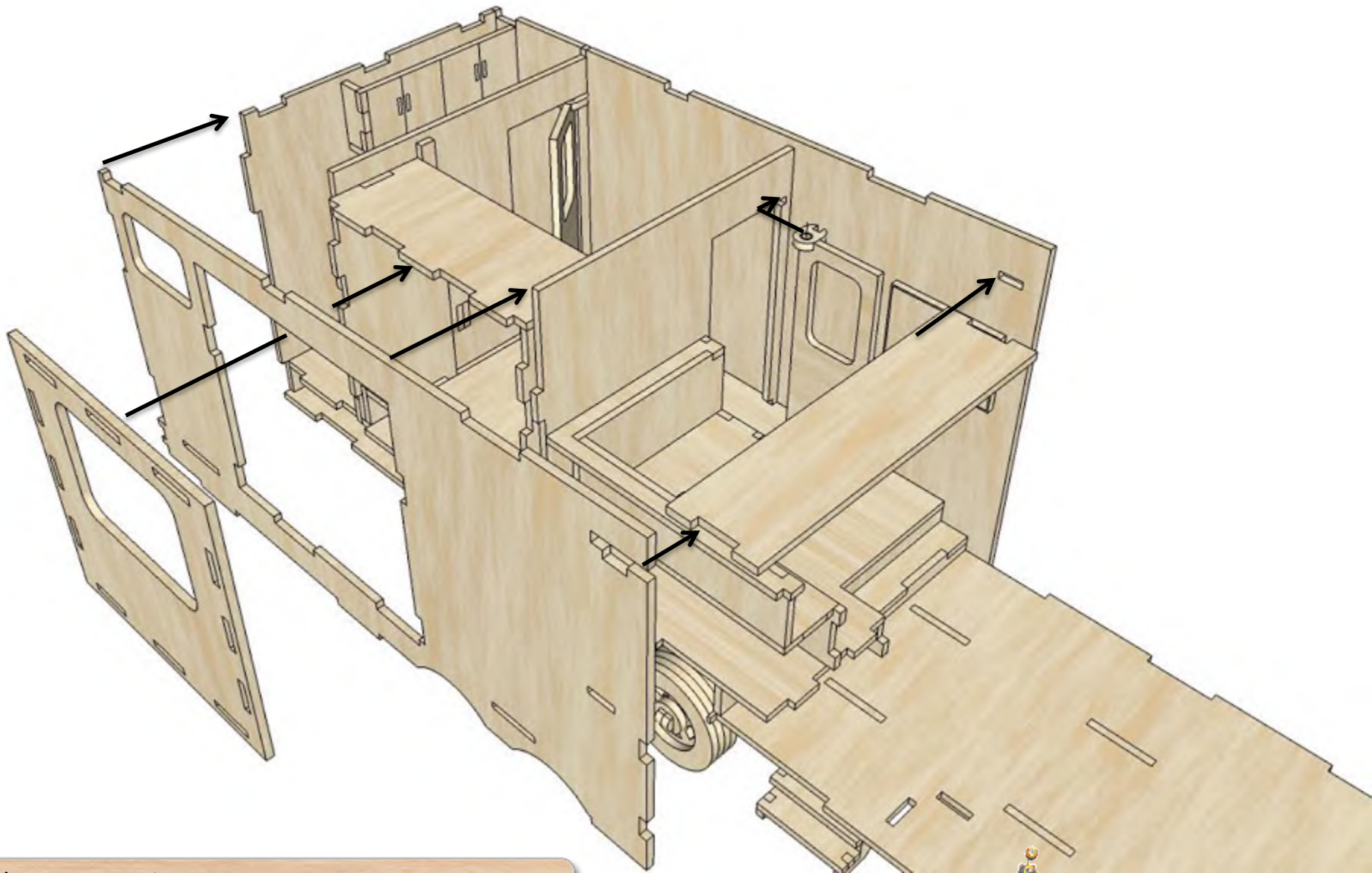

ASSEMBLY STEPS



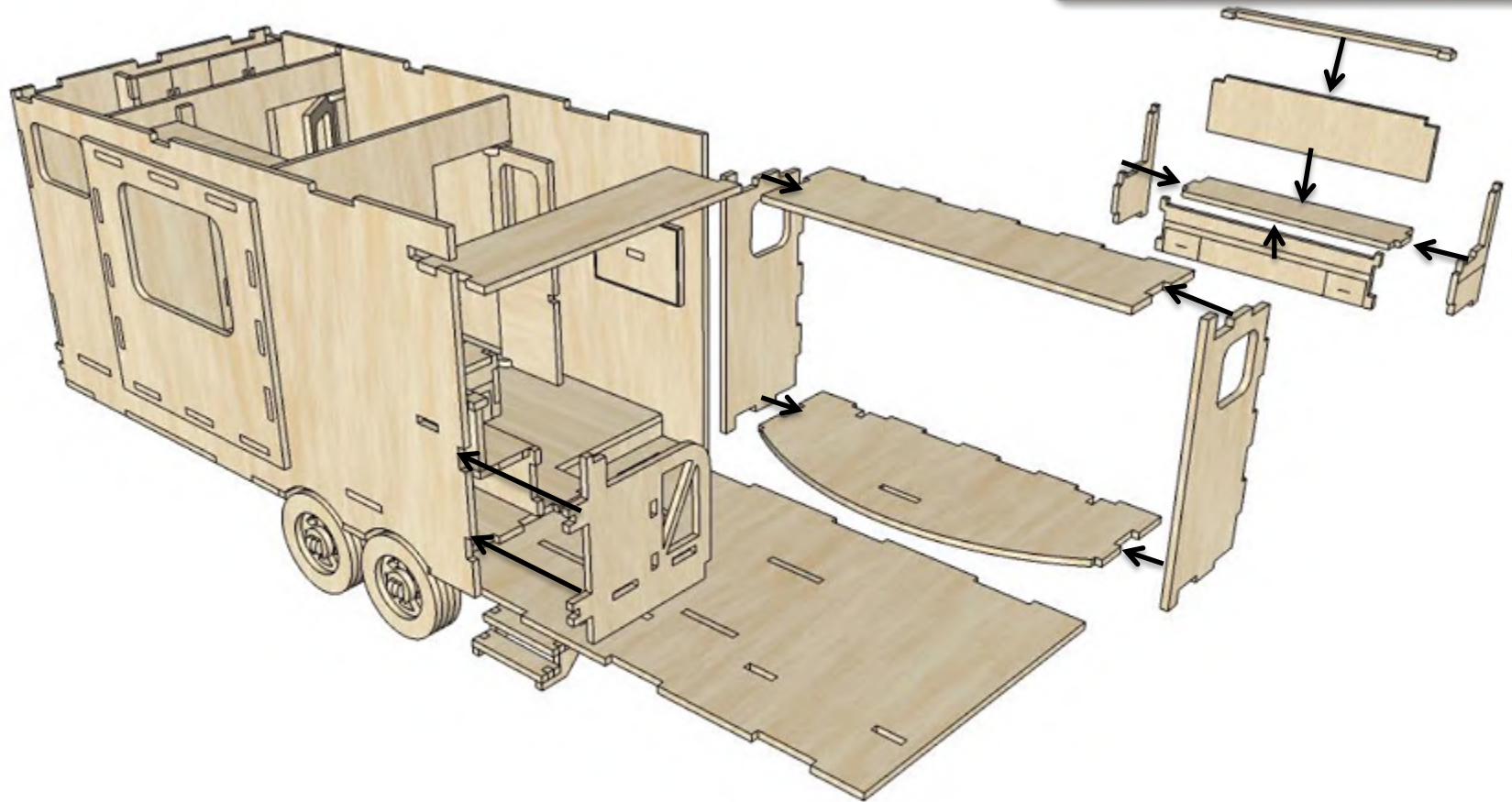

ASSEMBLY STEPS



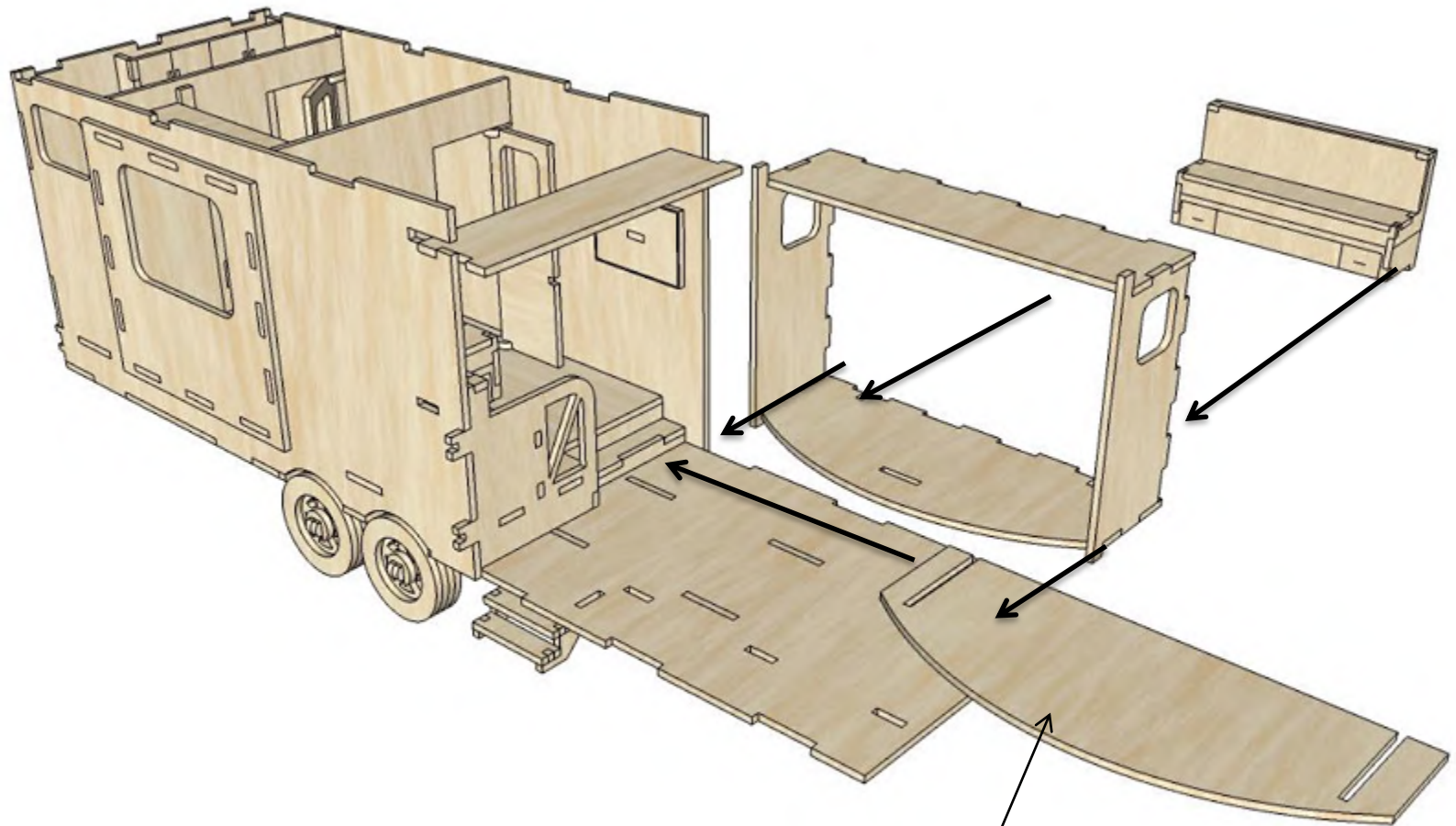

1ST STEP

ASSEMBLY STEPS



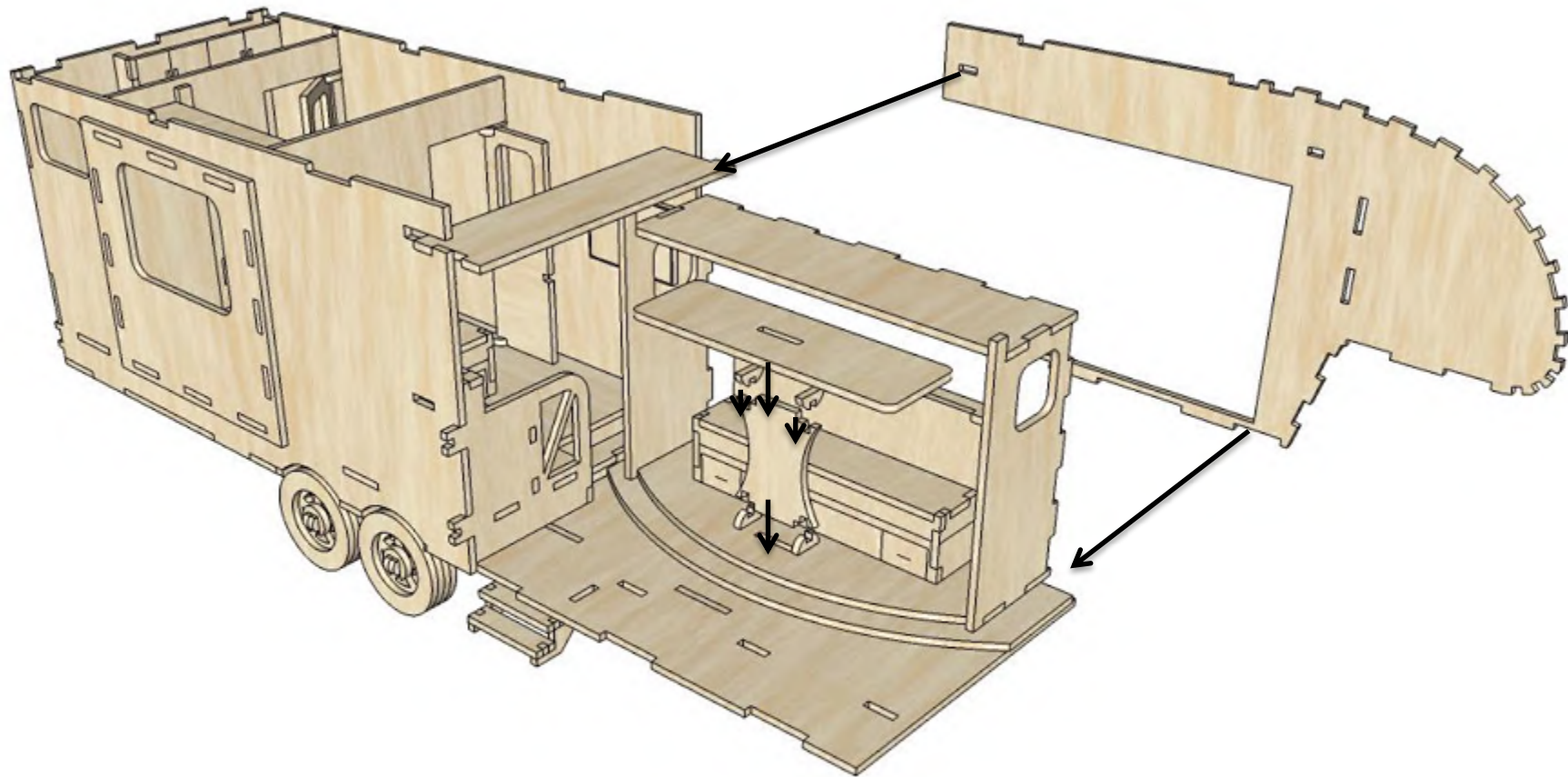

ASSEMBLY STEPS



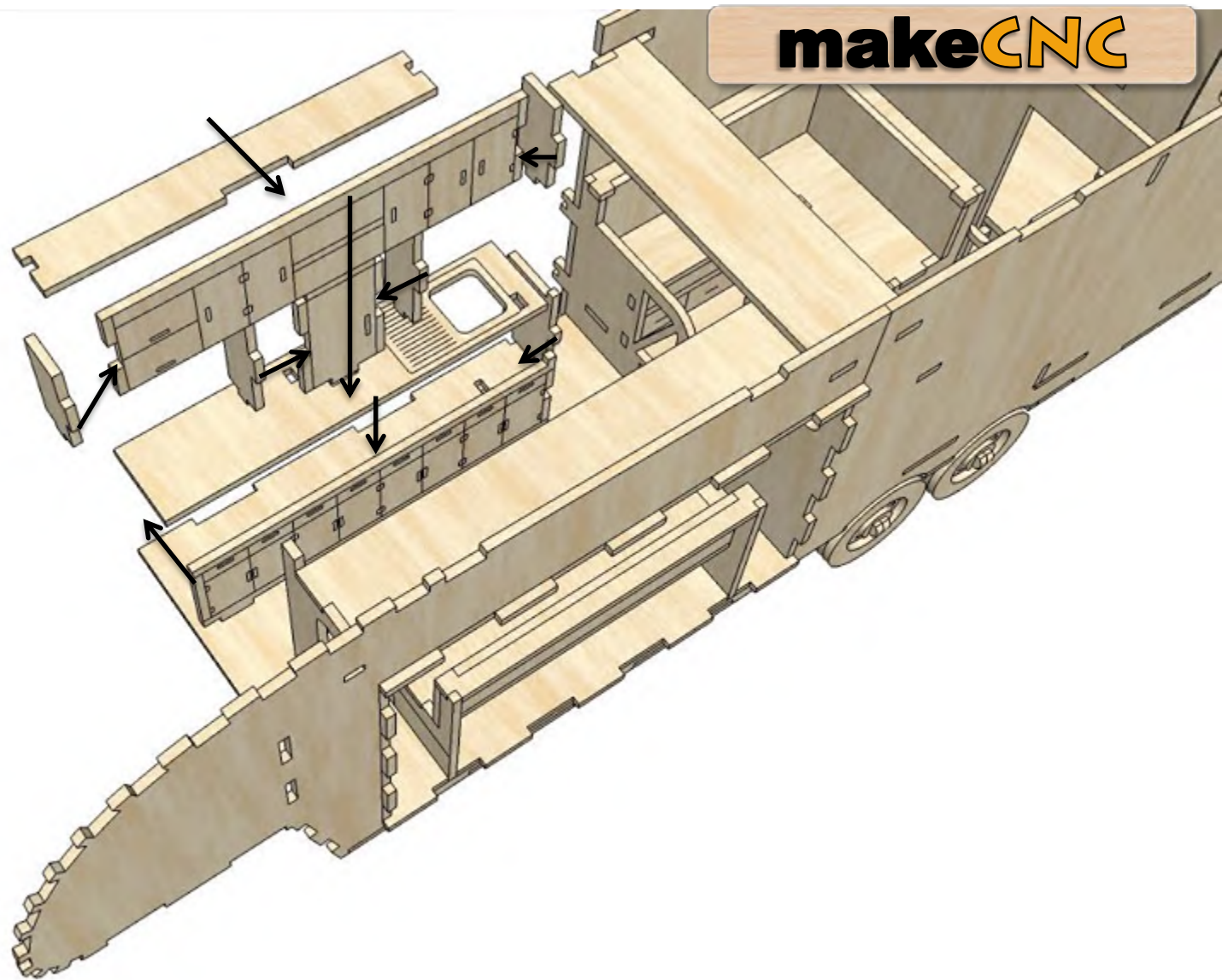

ASSEMBLY STEPS



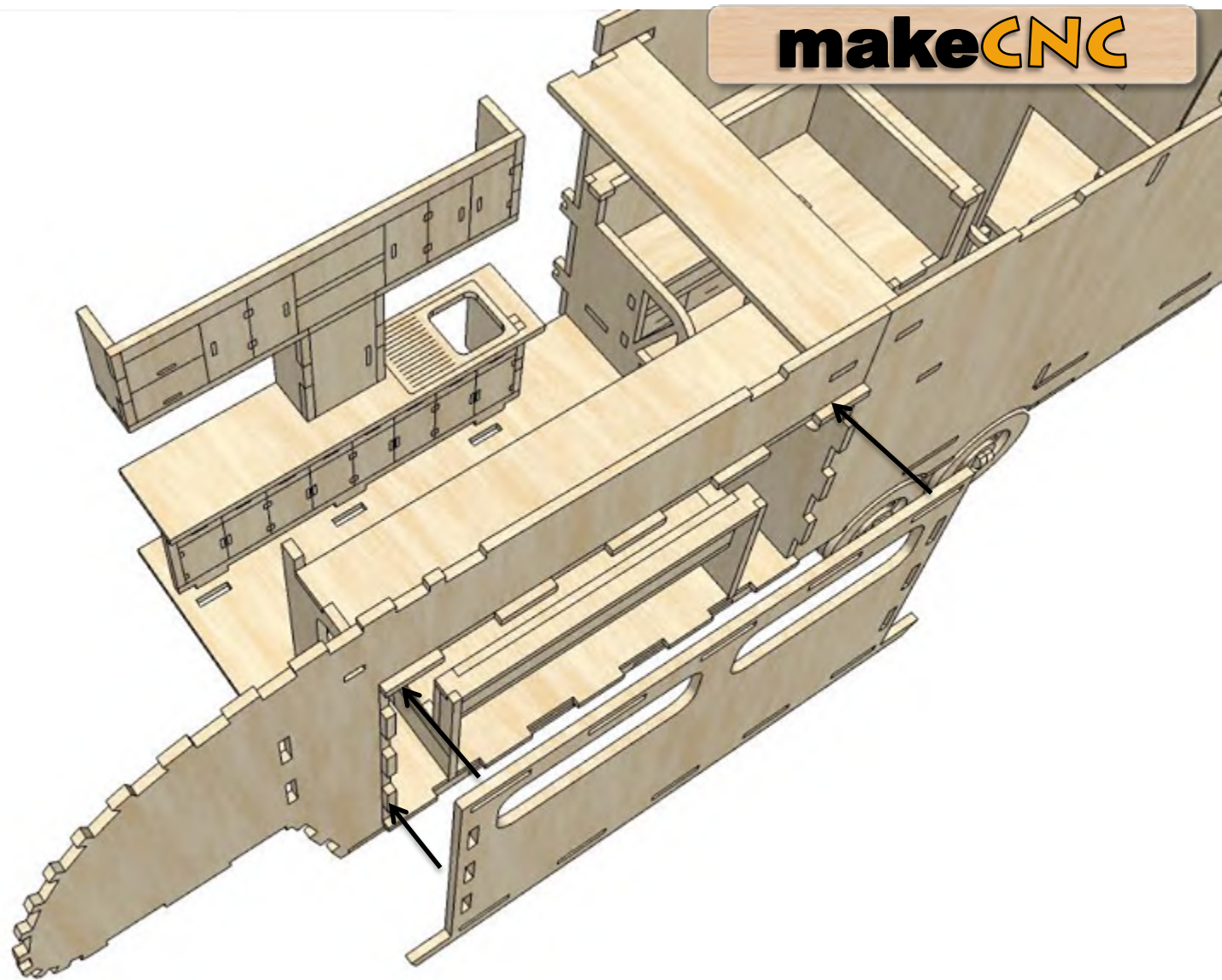

ASSEMBLY STEPS



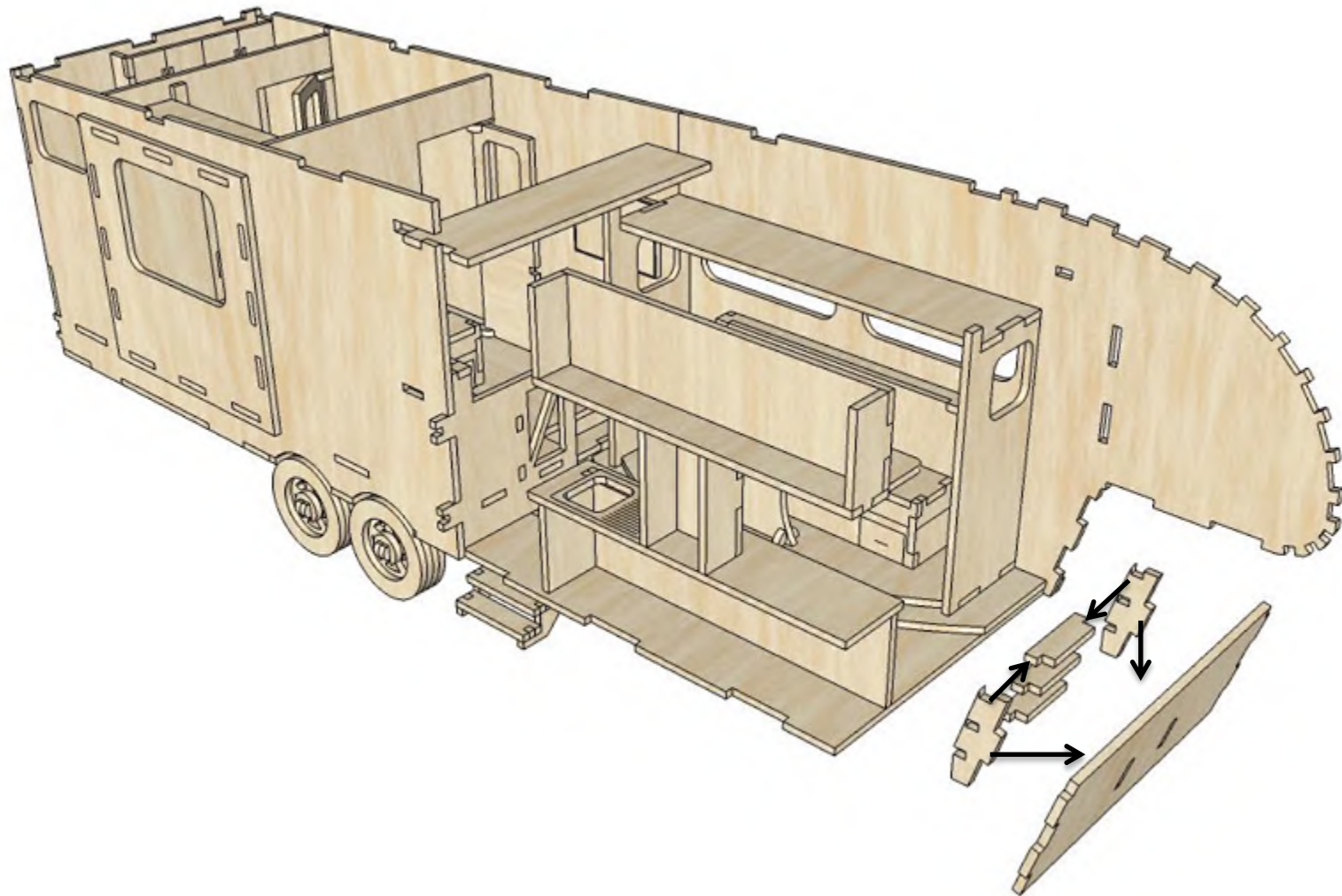

ASSEMBLY STEPS



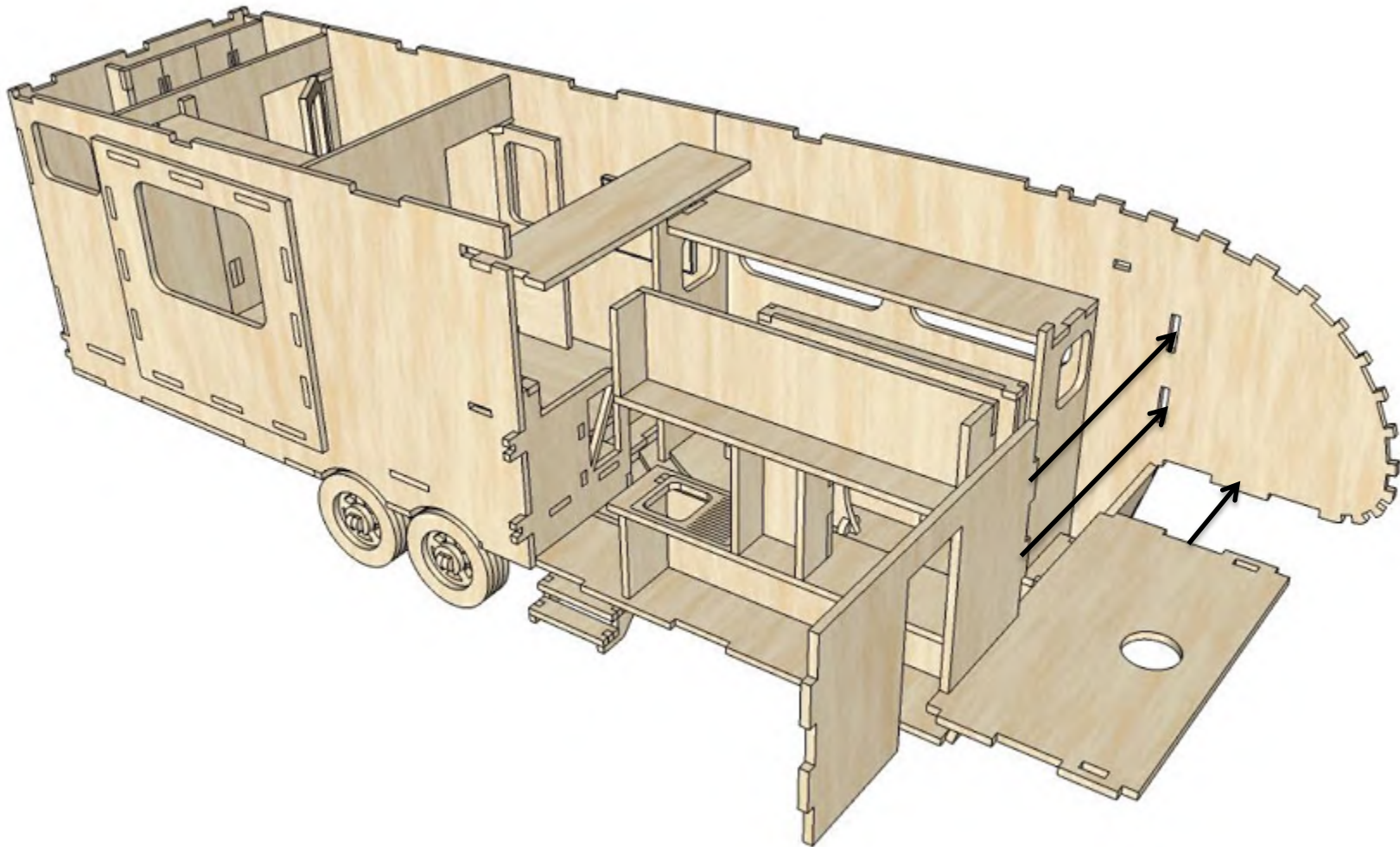

ASSEMBLY STEPS



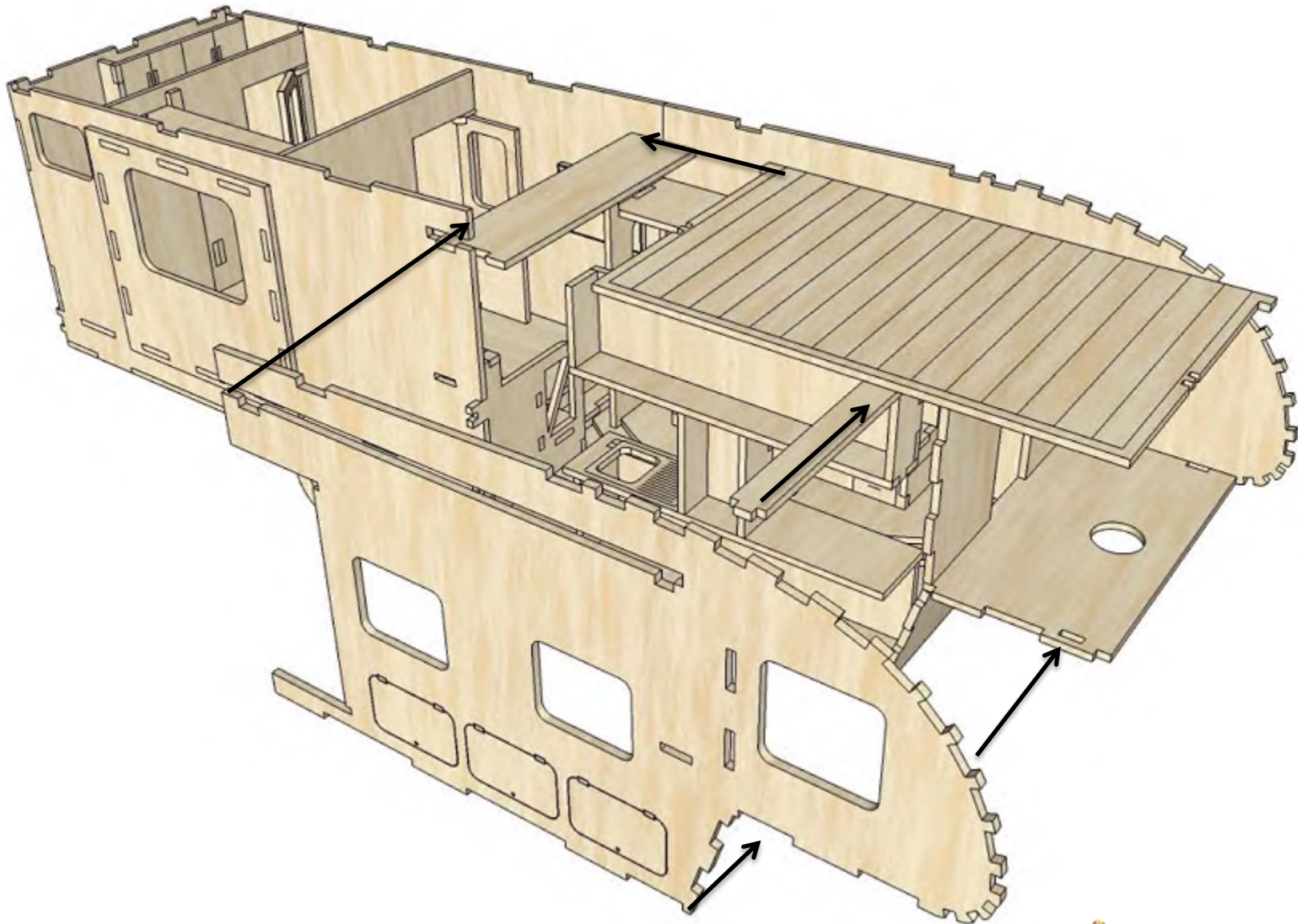

ASSEMBLY STEPS



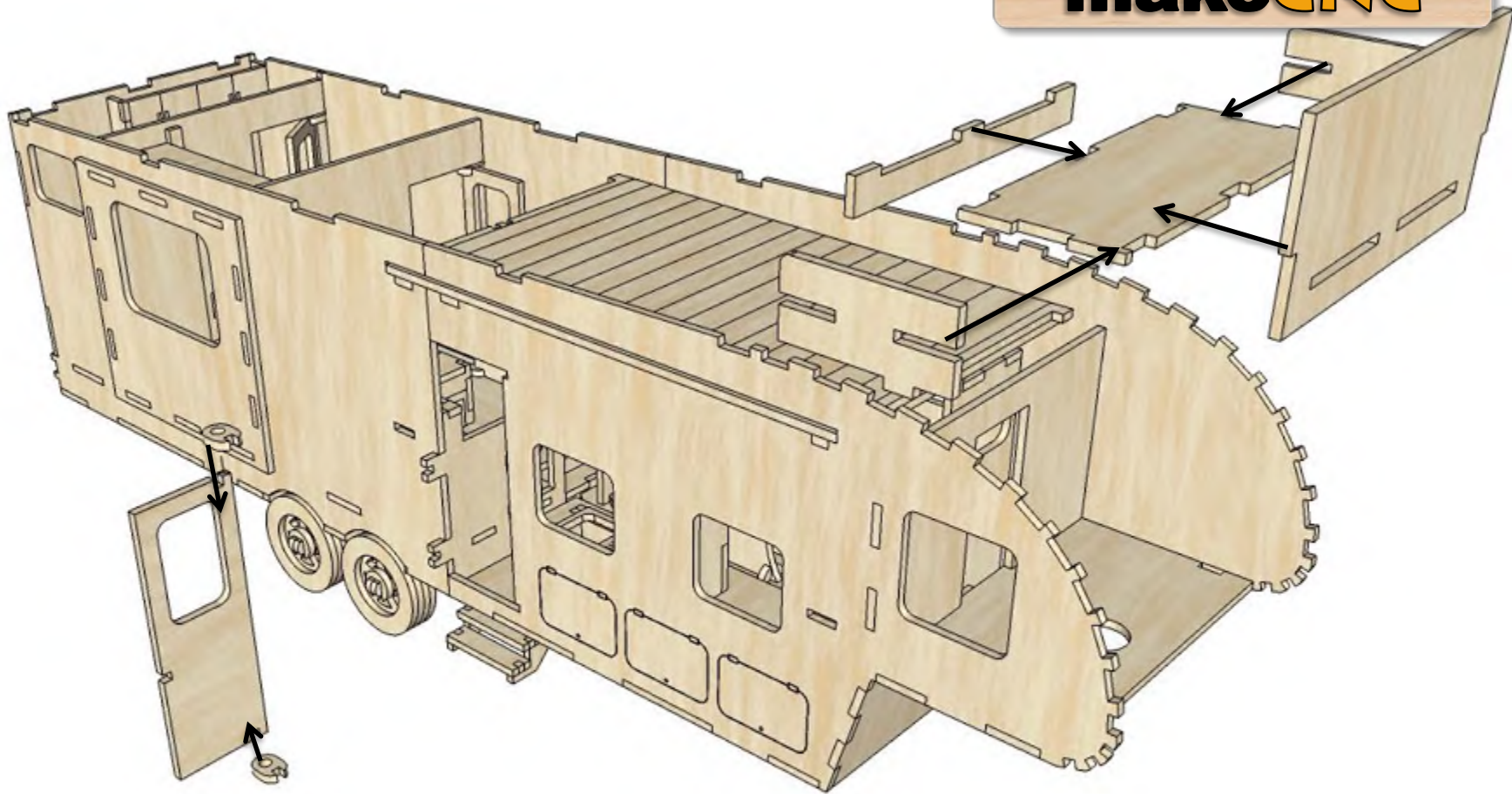

ASSEMBLY STEPS



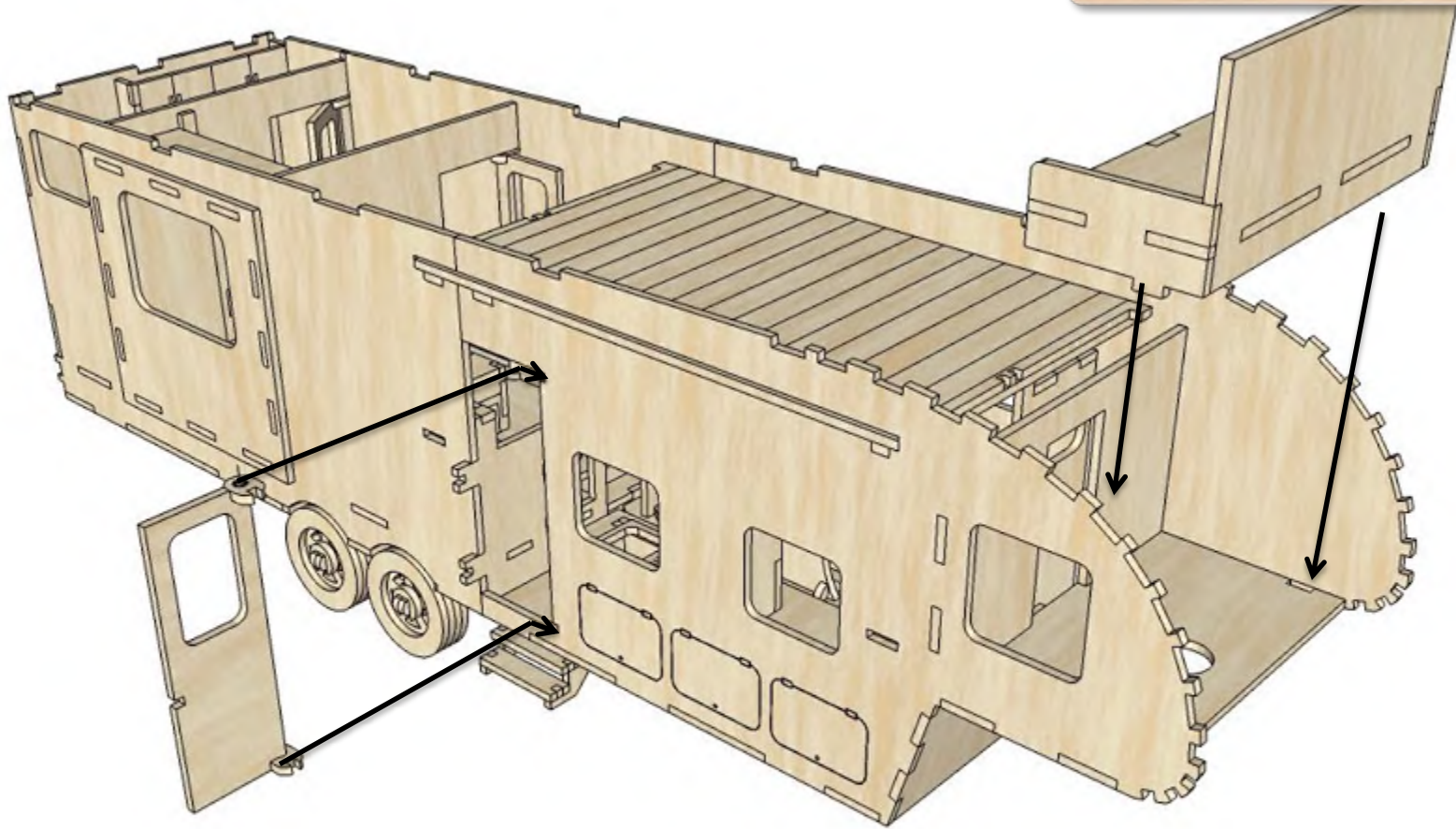

ASSEMBLY STEPS



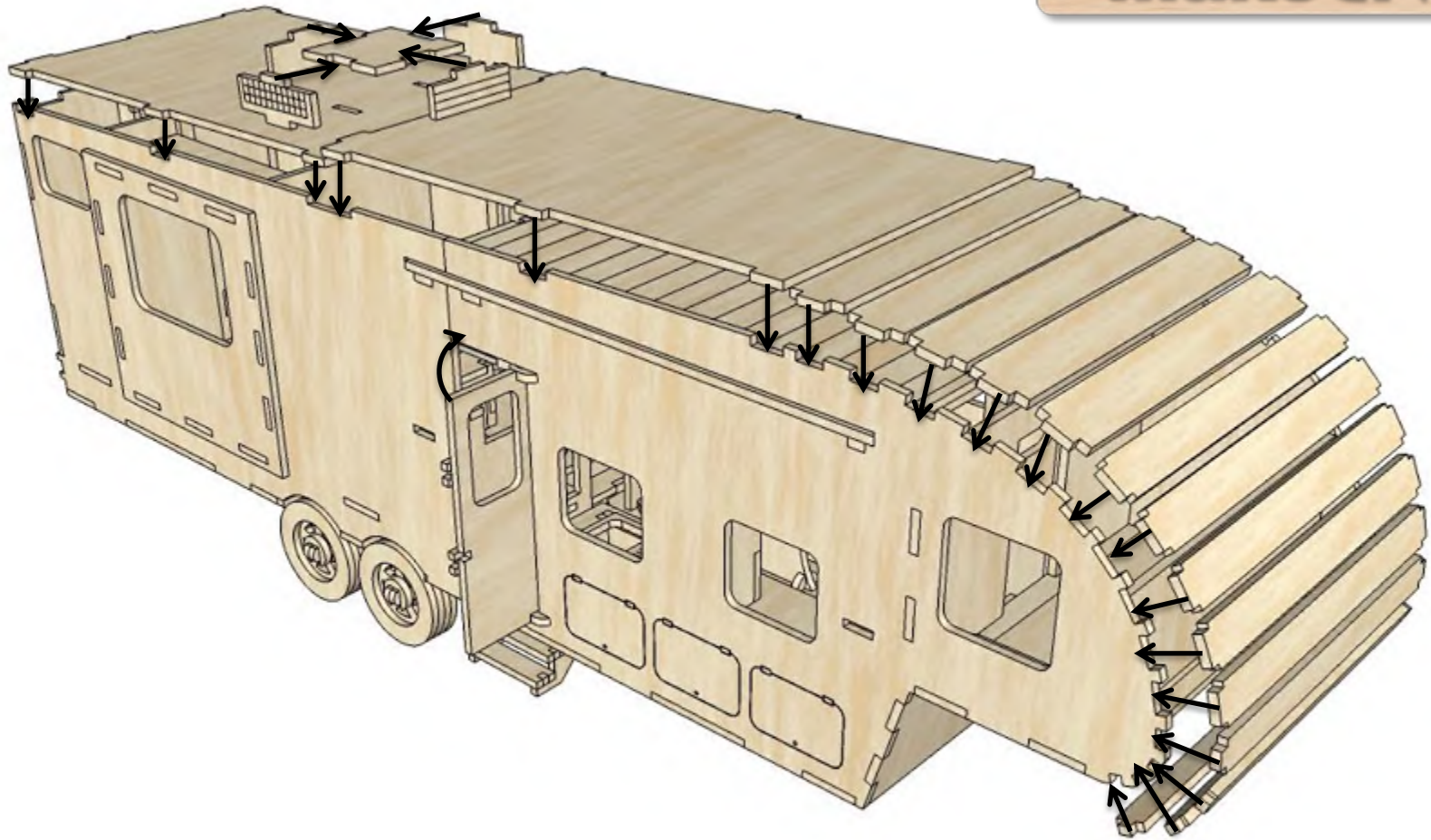

ASSEMBLY STEPS



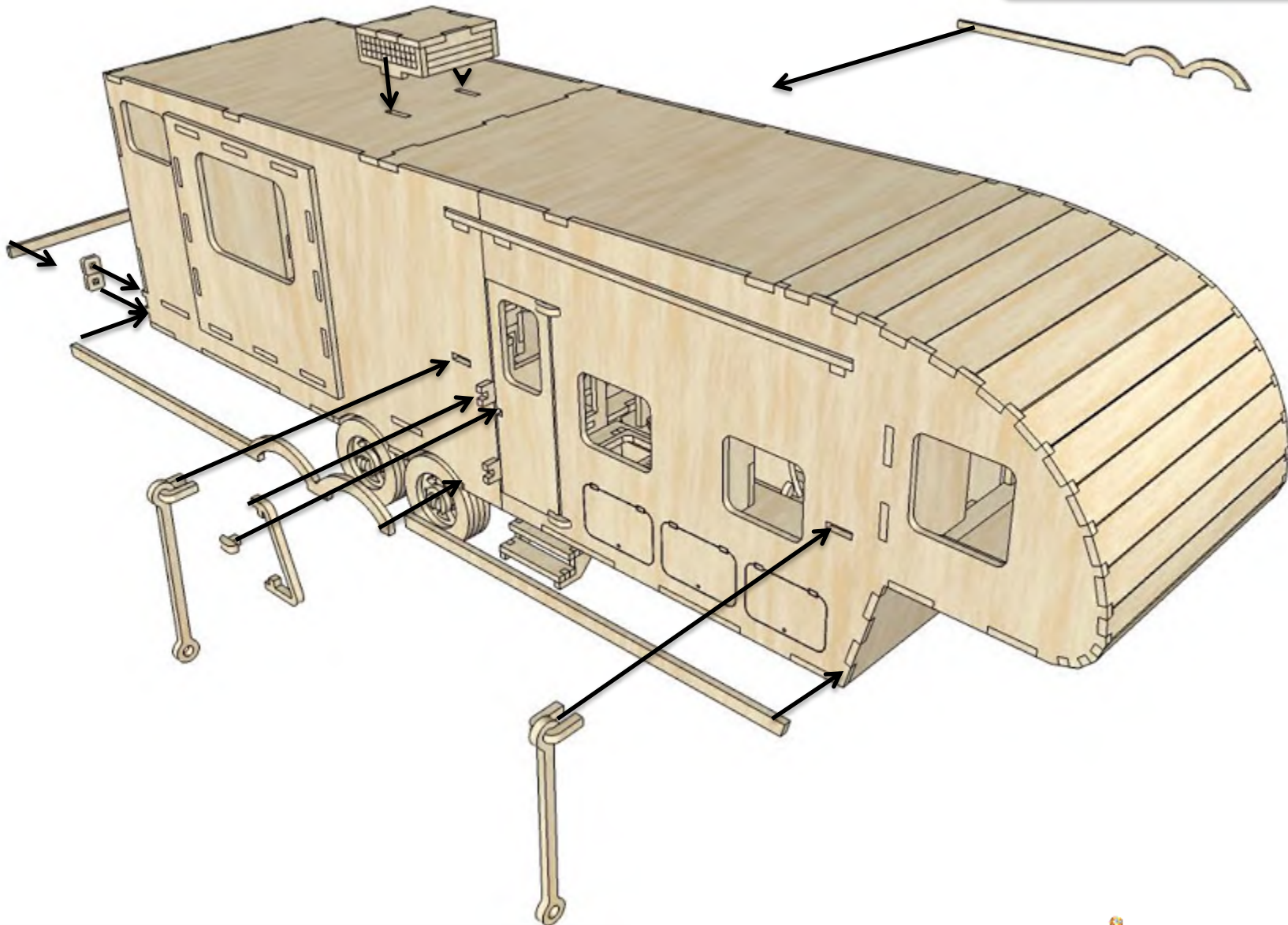

ASSEMBLY STEPS



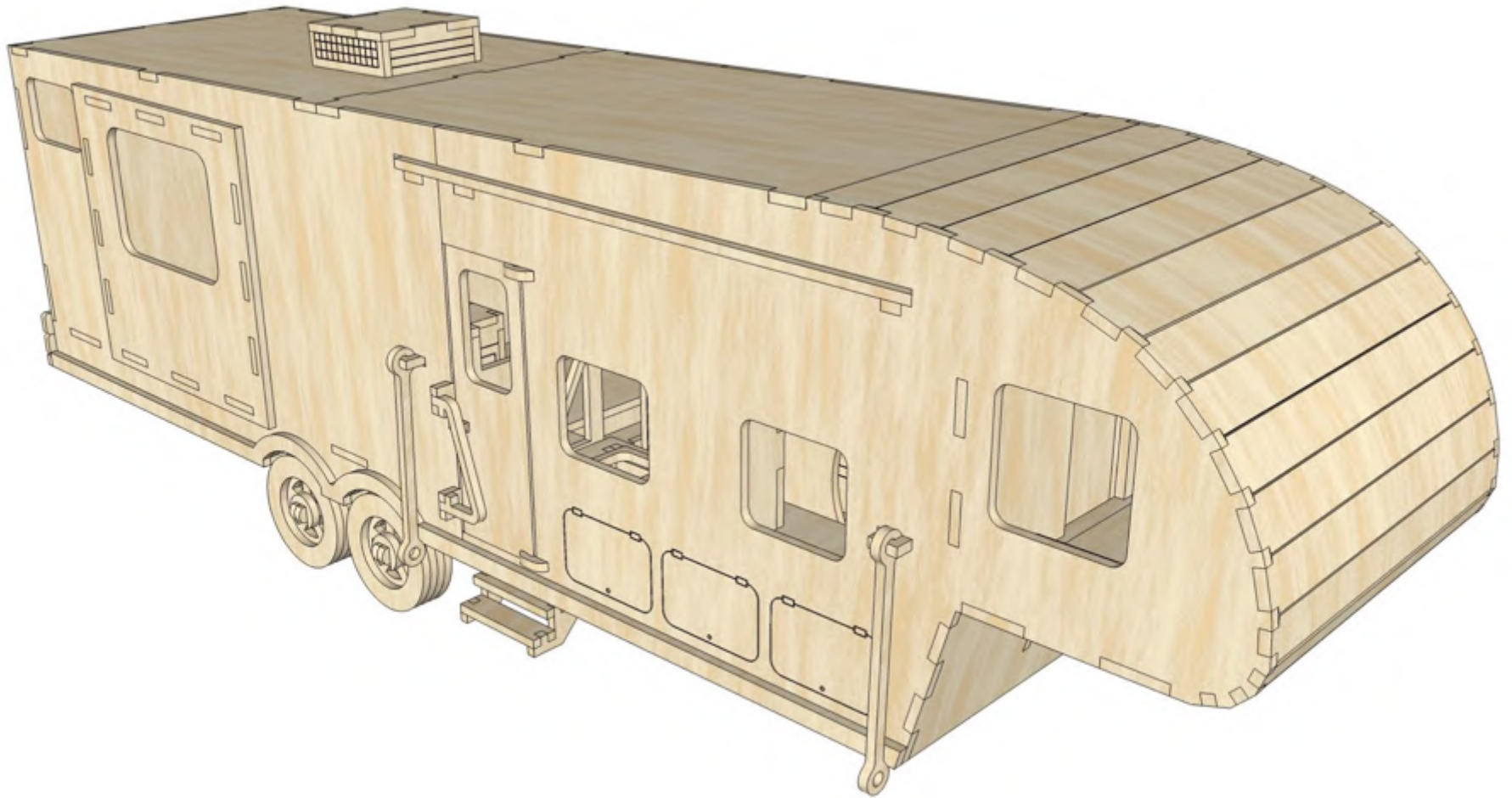

FINAL



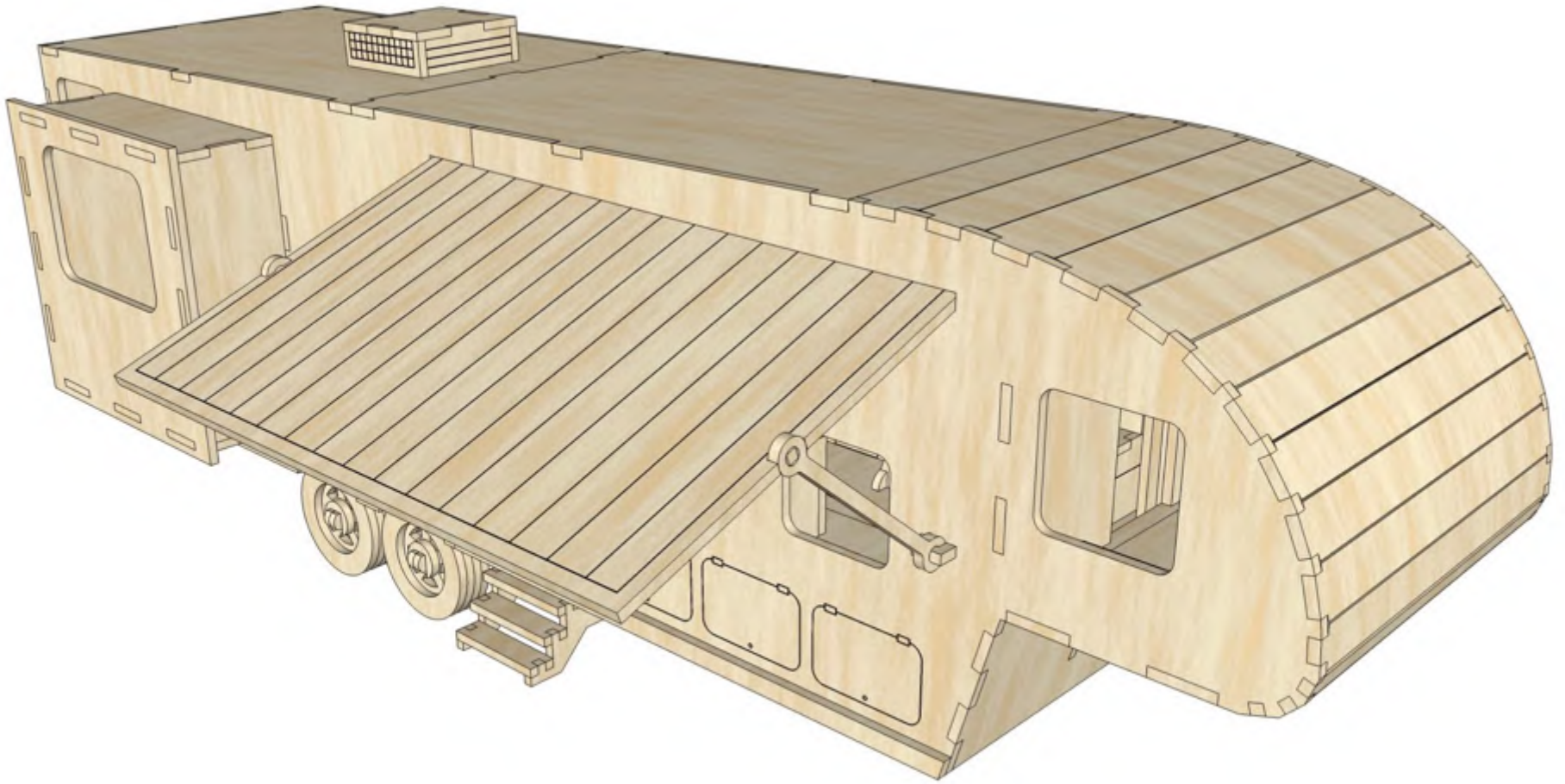

FINAL





FINAL

