

makeCNC



STARSHIP ENTERPRISE



makeCNC
Robotic Tools & other Machines

www.makecnc.com

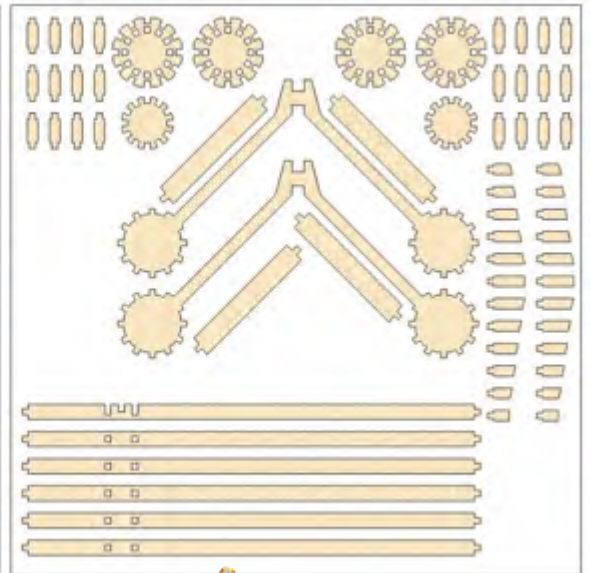
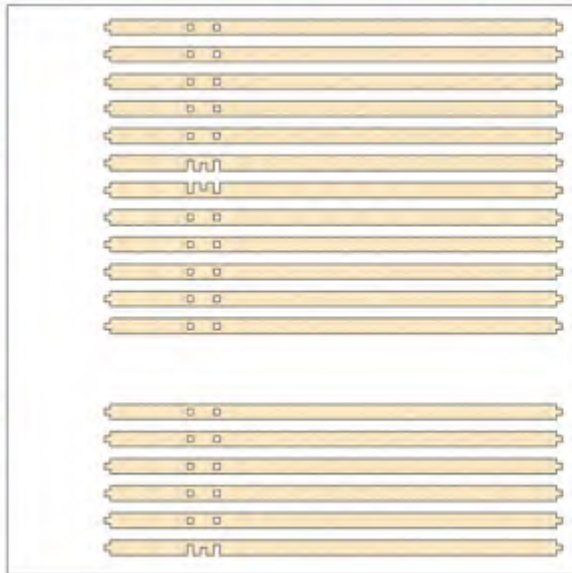
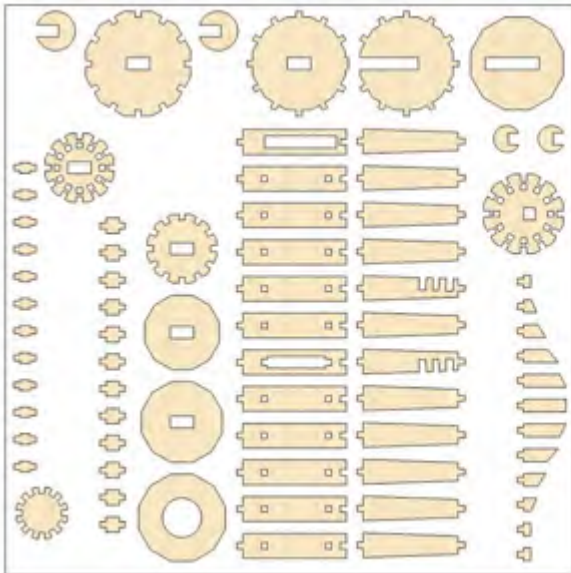
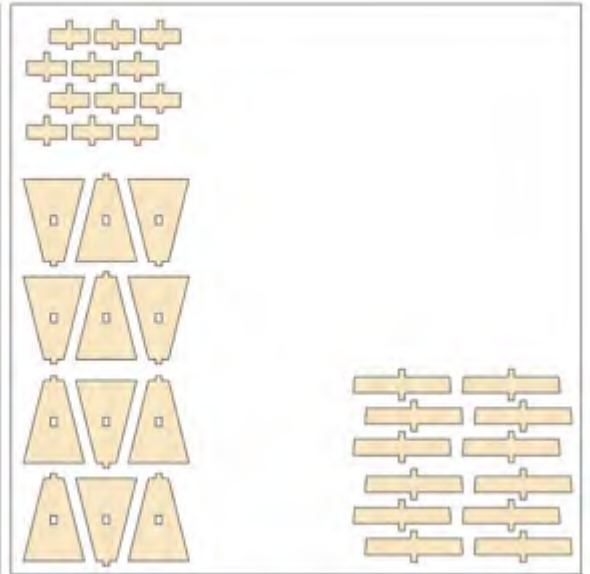
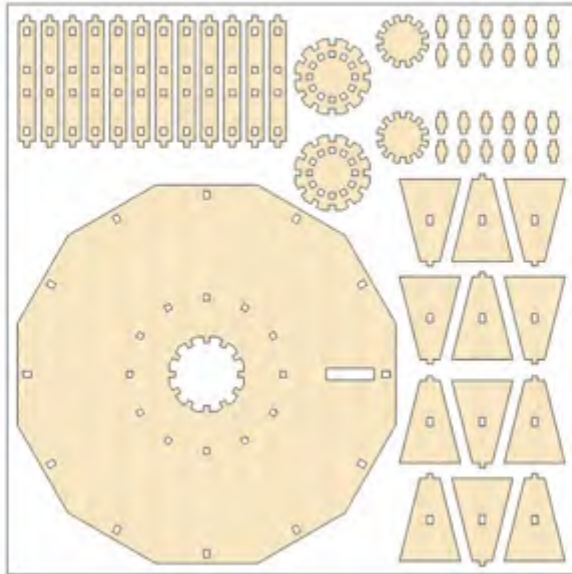
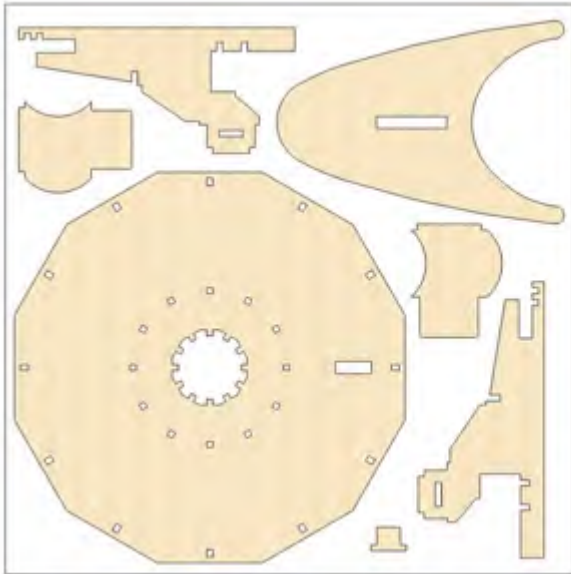

PARTS LIST



IT IS RECOMMENDED TO GO THROUGH ALL THE PAGES
AND SEE EACH STEP BEFORE STARTING THE ASSEMBLY

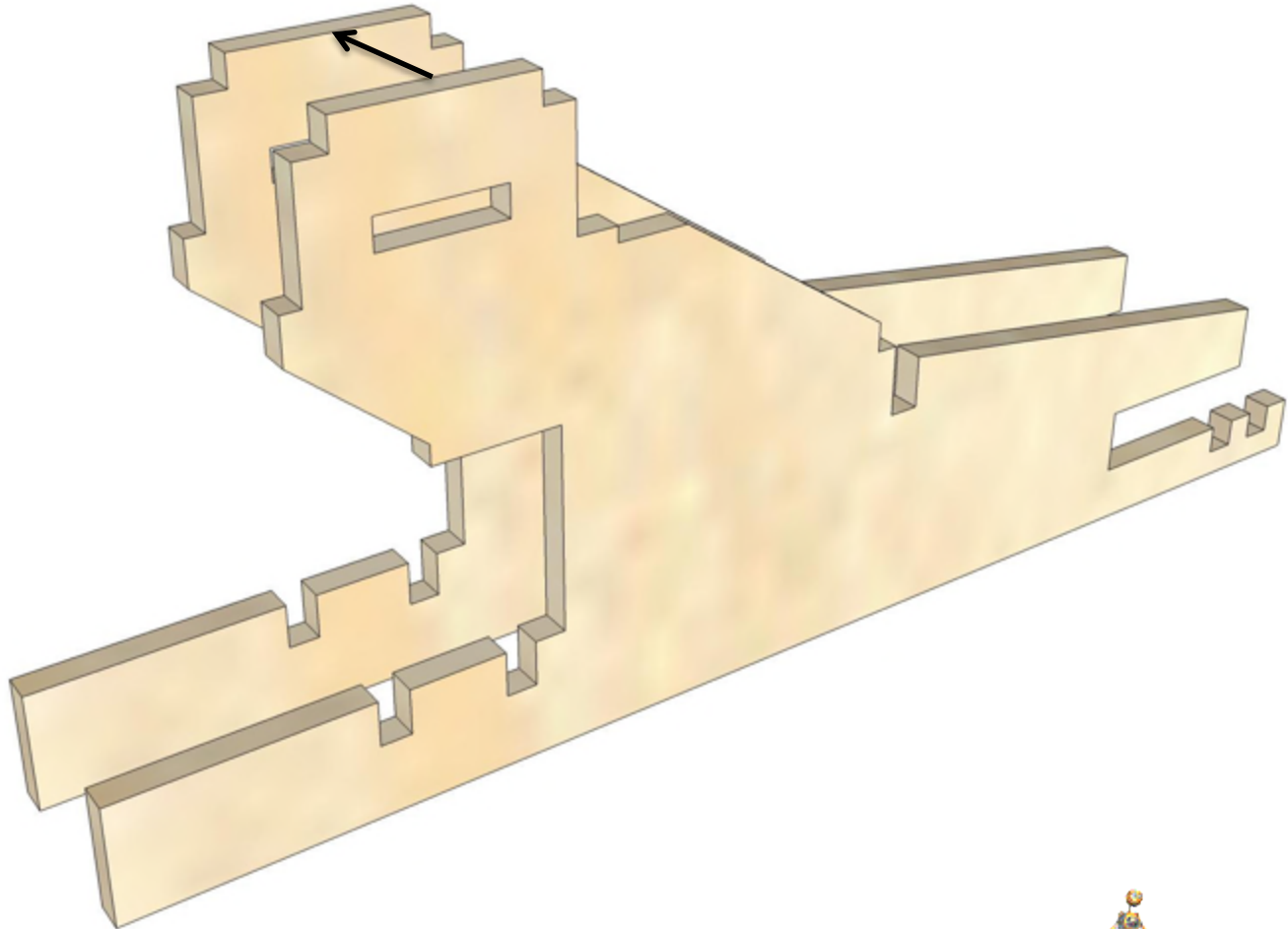

ASSEMBLY STEPS



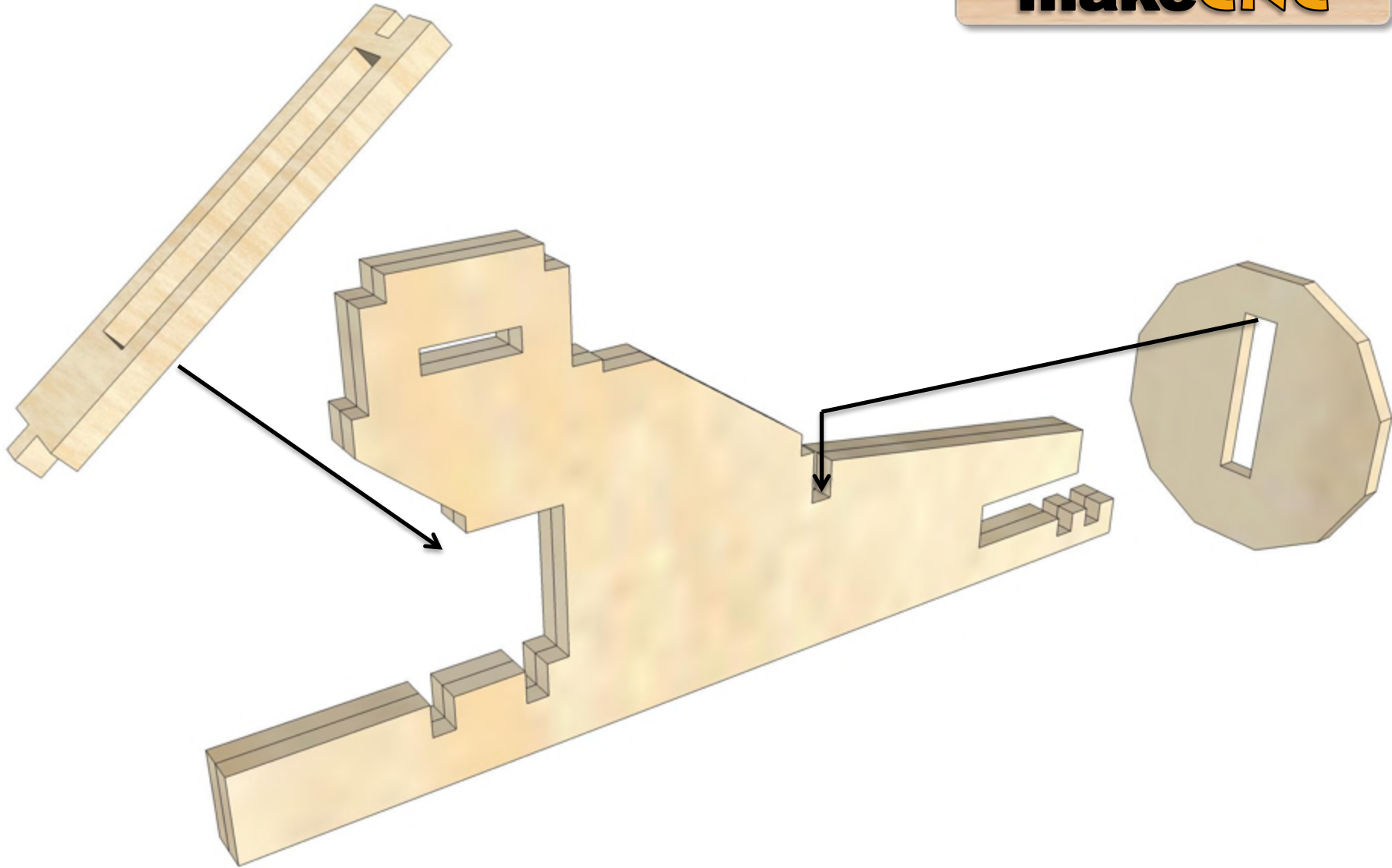

ASSEMBLY STEPS



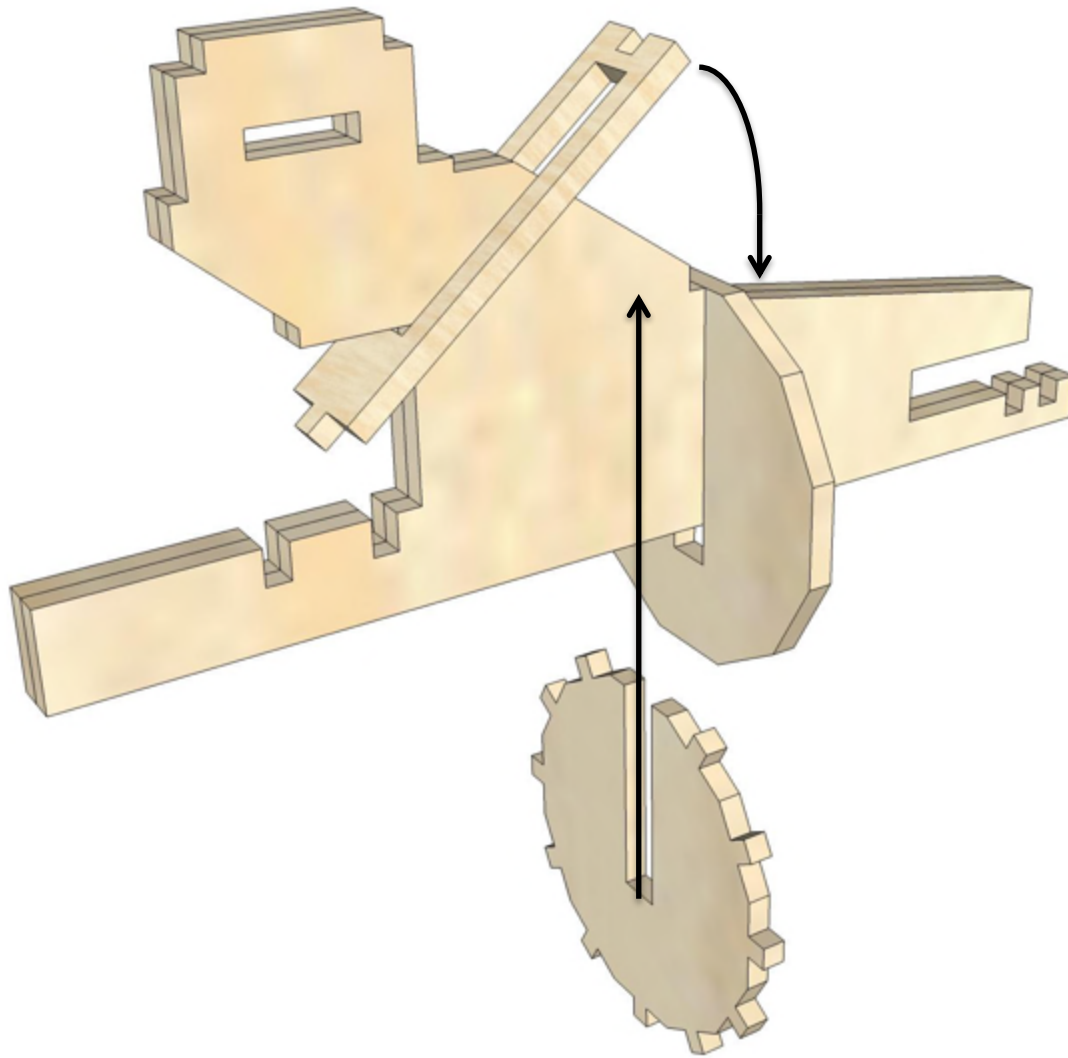

ASSEMBLY STEPS



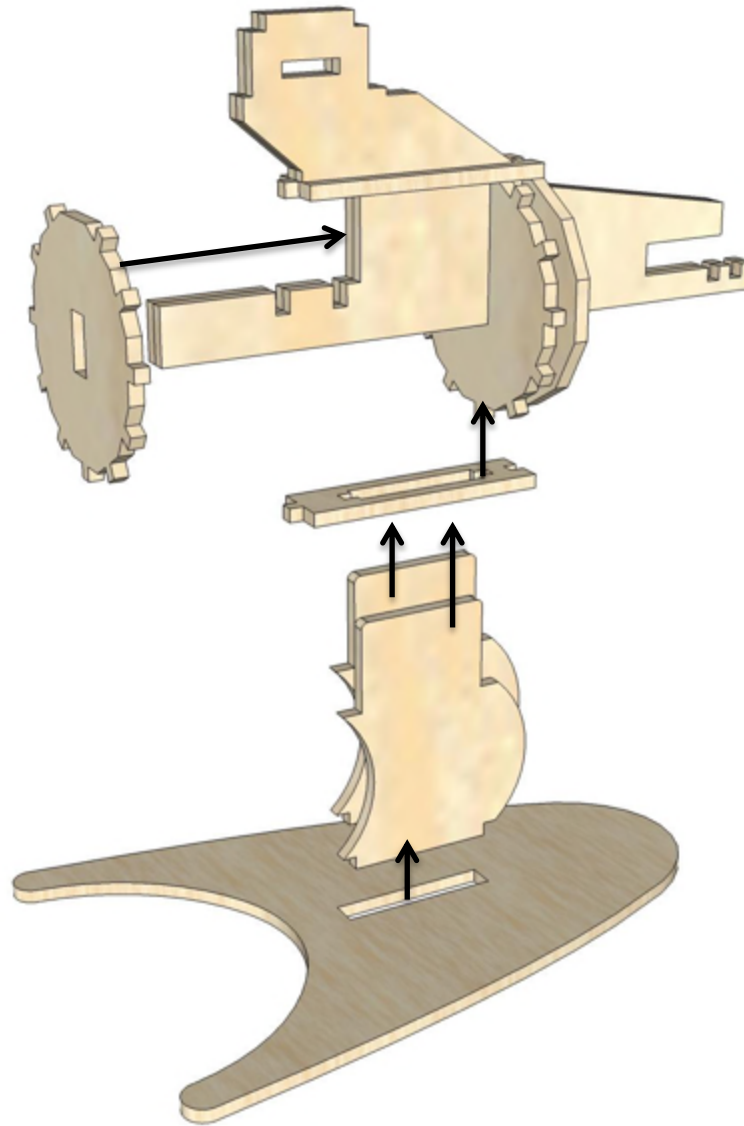

ASSEMBLY STEPS



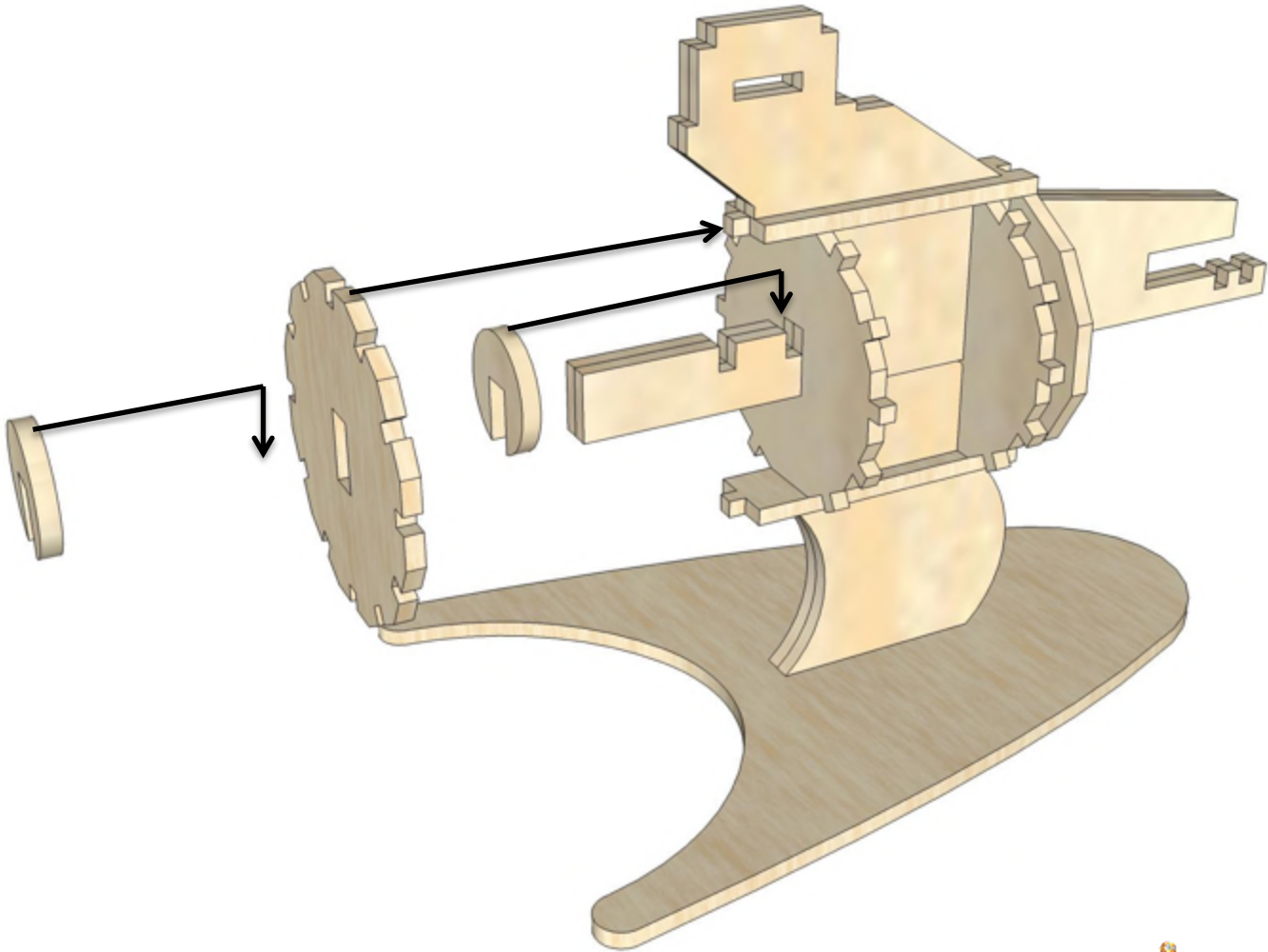

ASSEMBLY STEPS



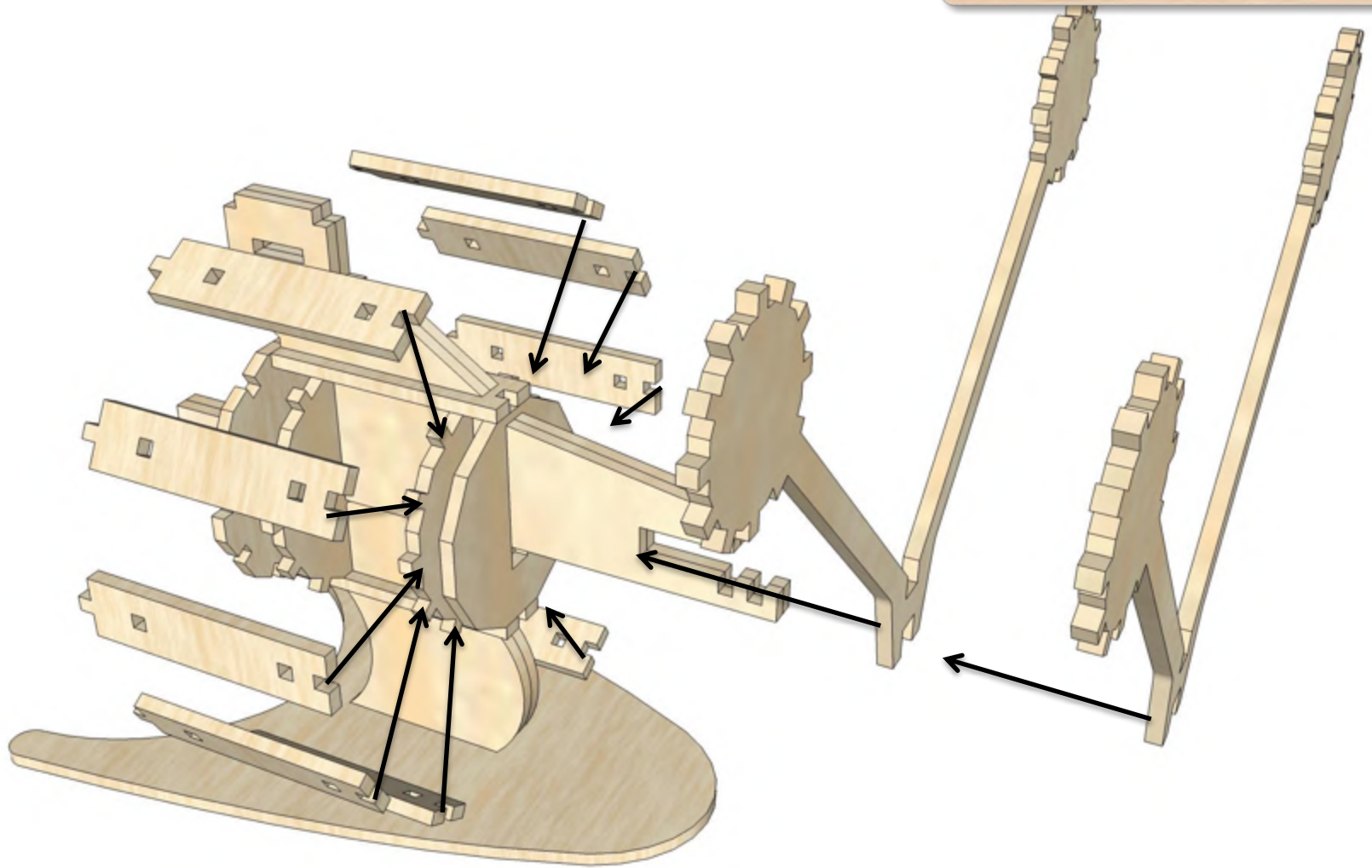

ASSEMBLY STEPS



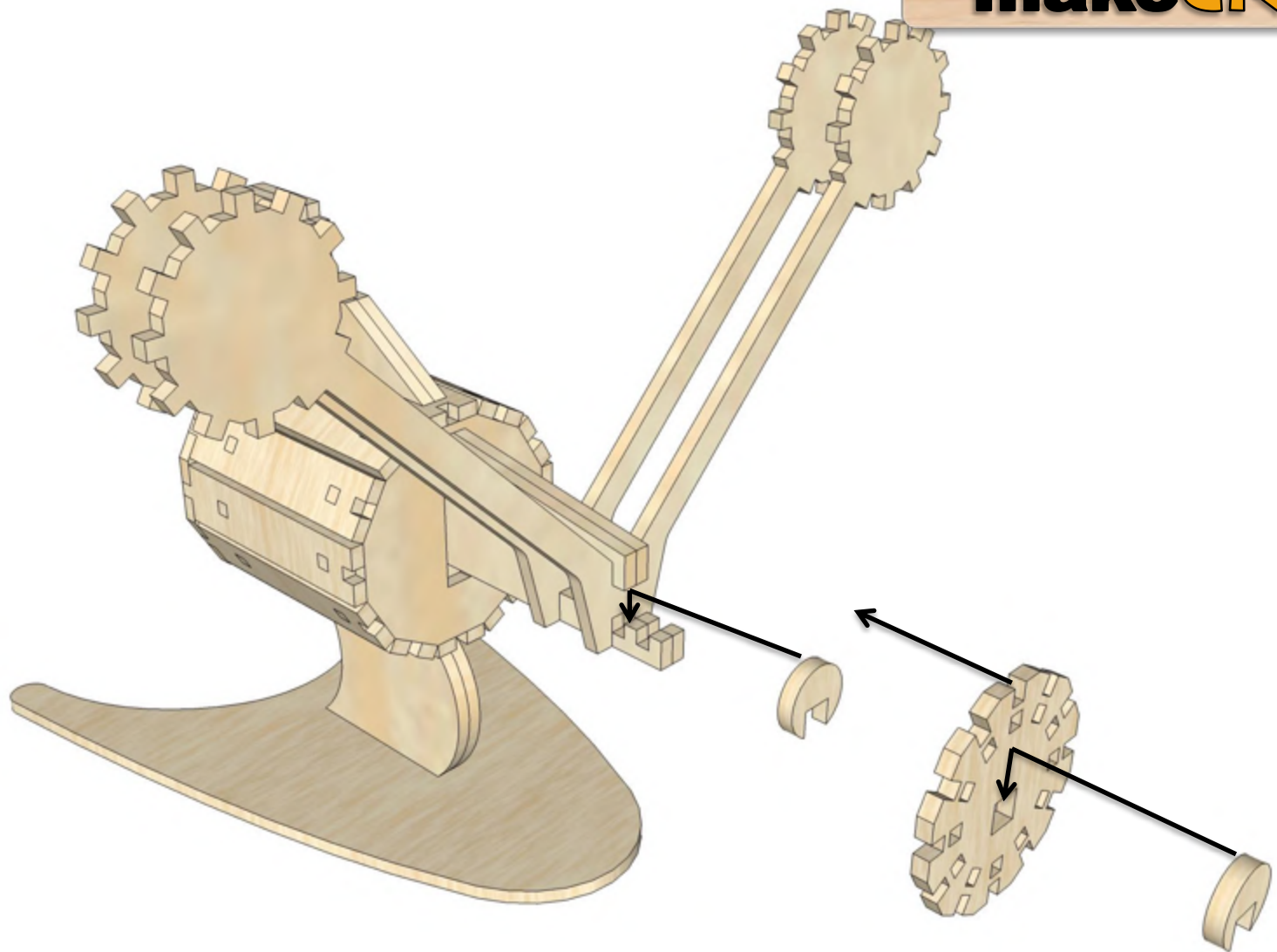

ASSEMBLY STEPS



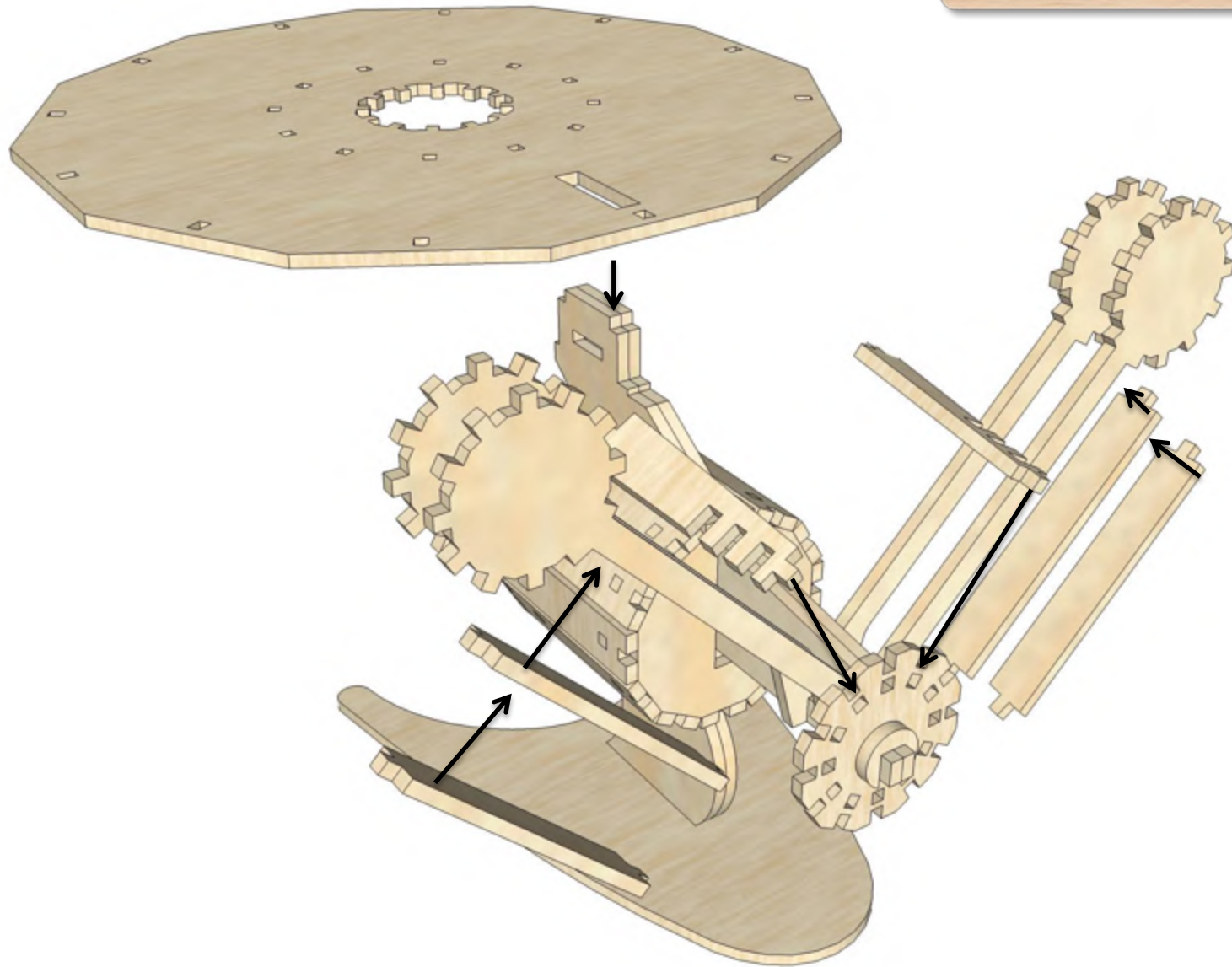

ASSEMBLY STEPS



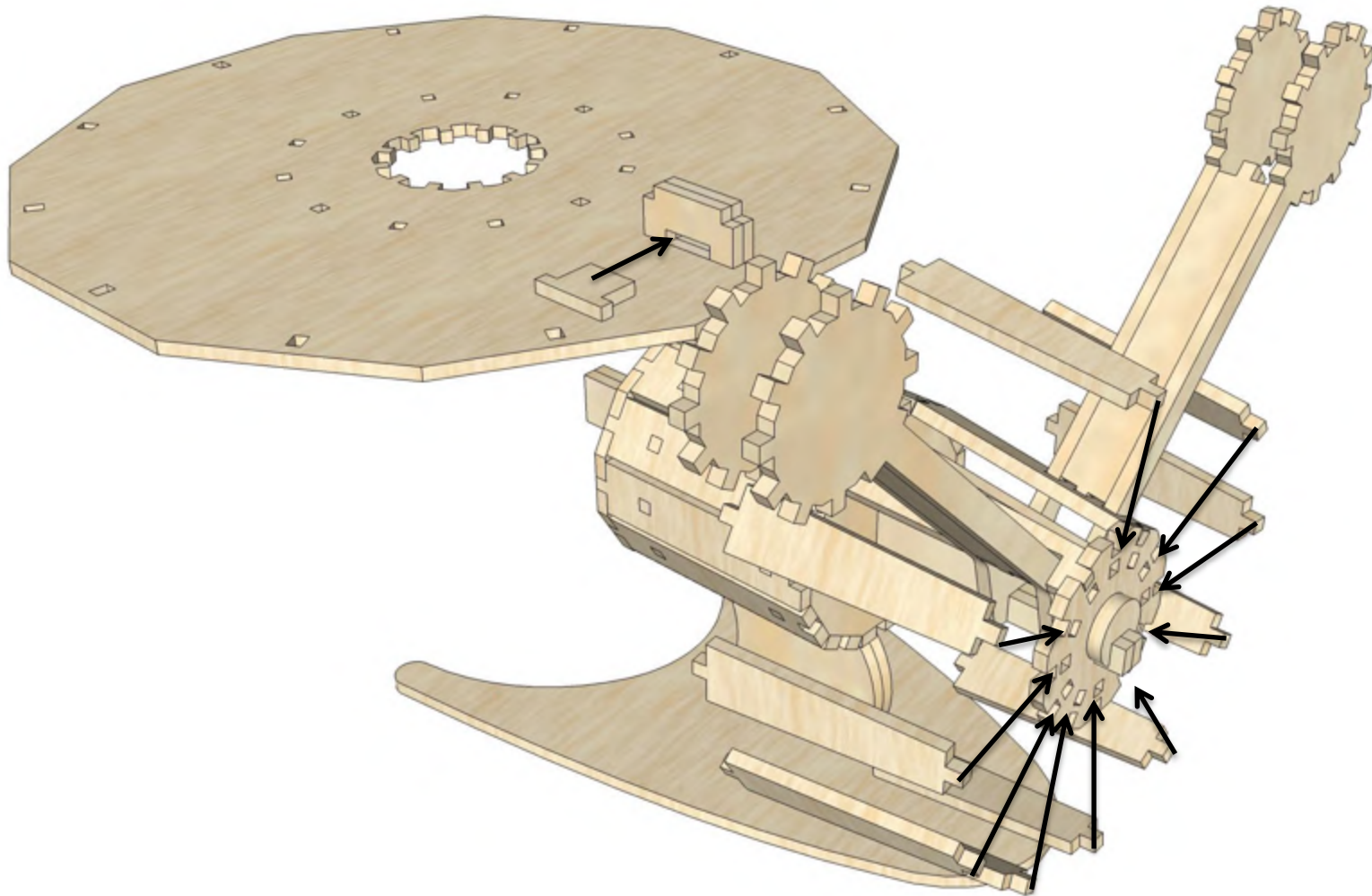

ASSEMBLY STEPS



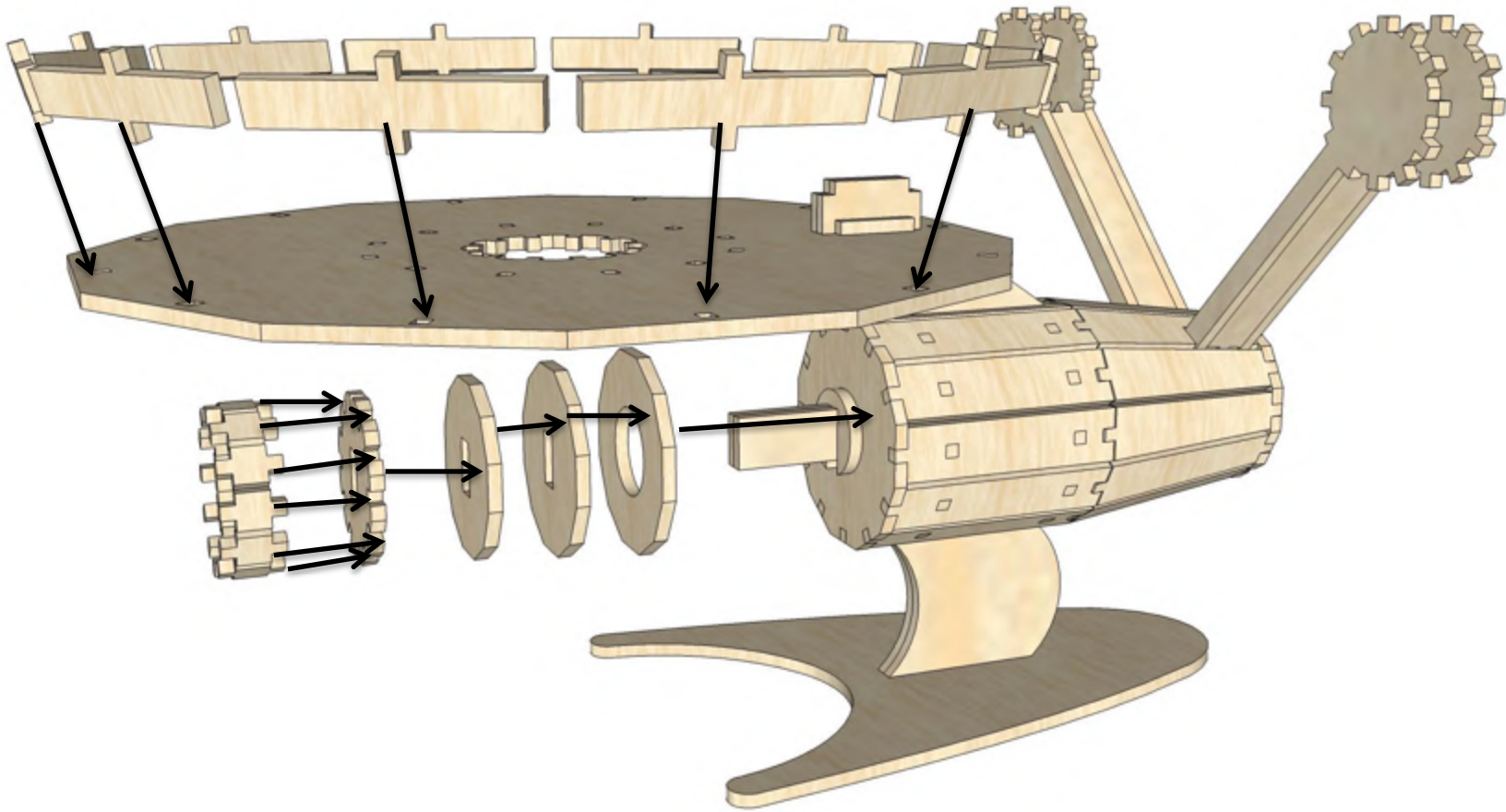

ASSEMBLY STEPS



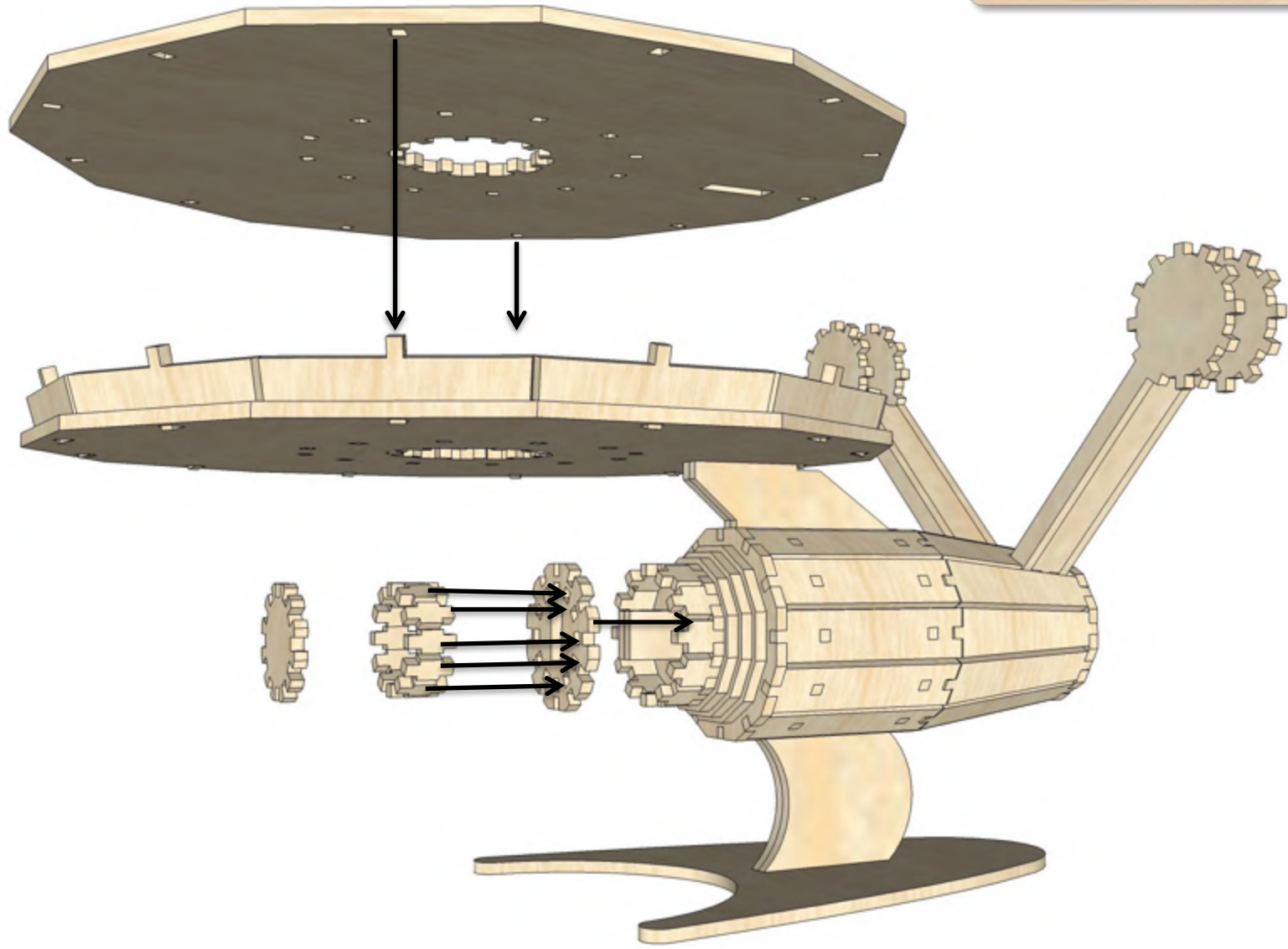

ASSEMBLY STEPS



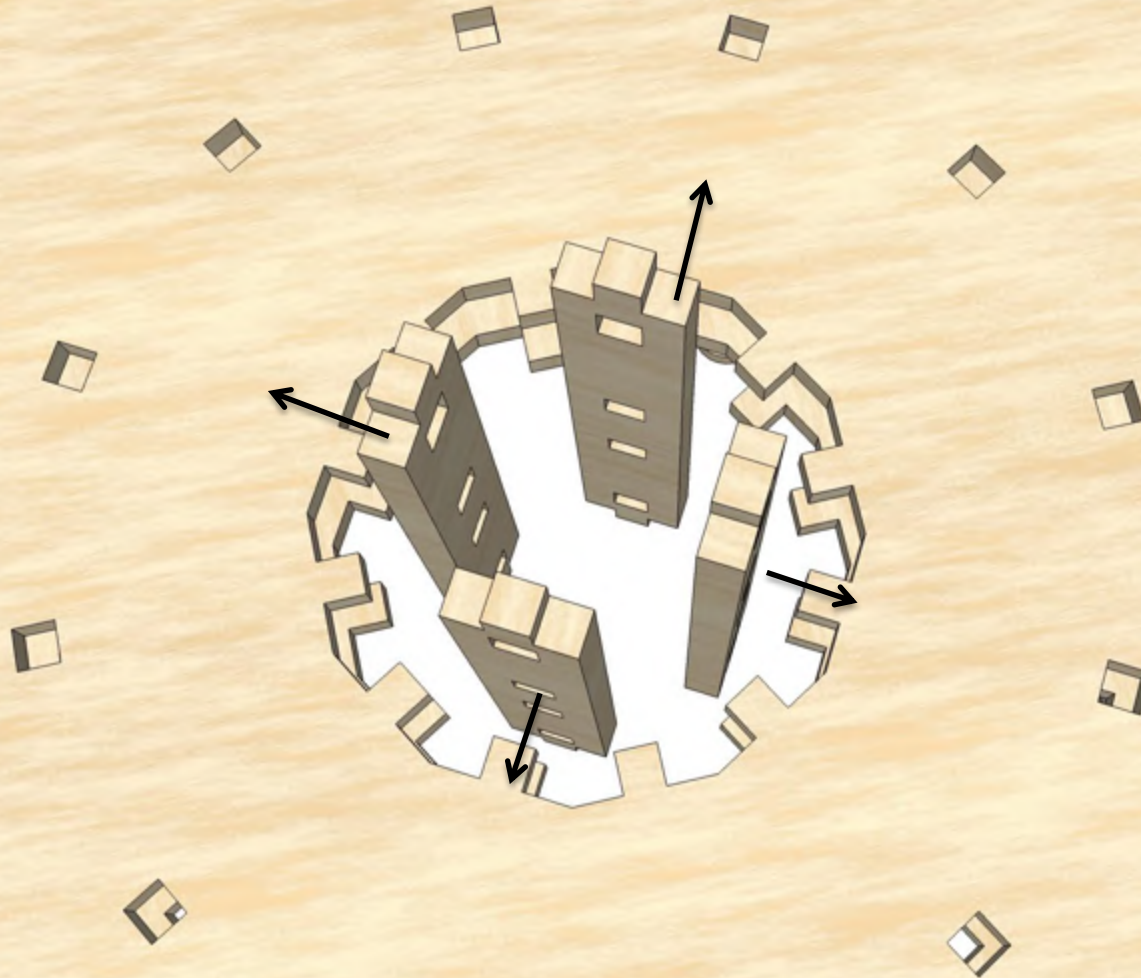

ASSEMBLY STEPS



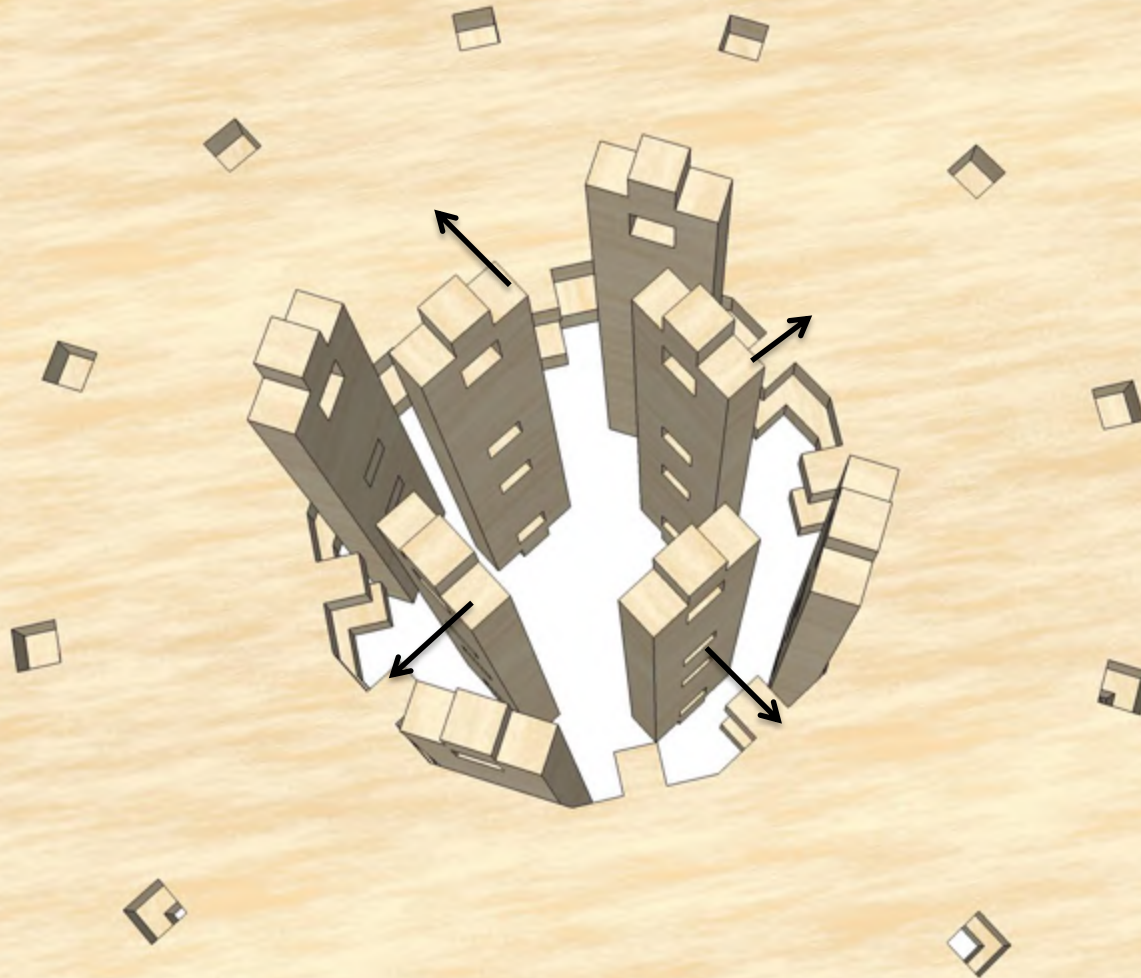

ASSEMBLY STEPS



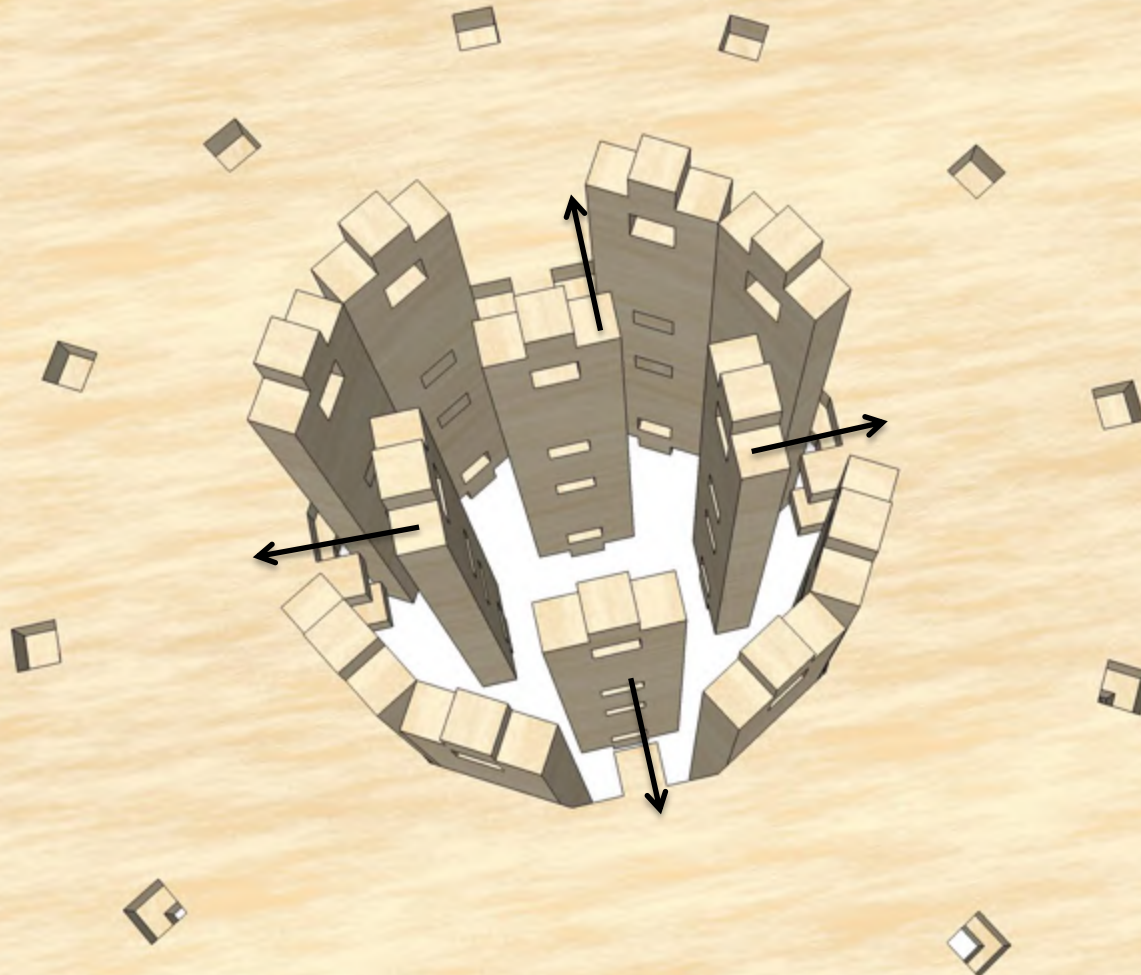

ASSEMBLY STEPS



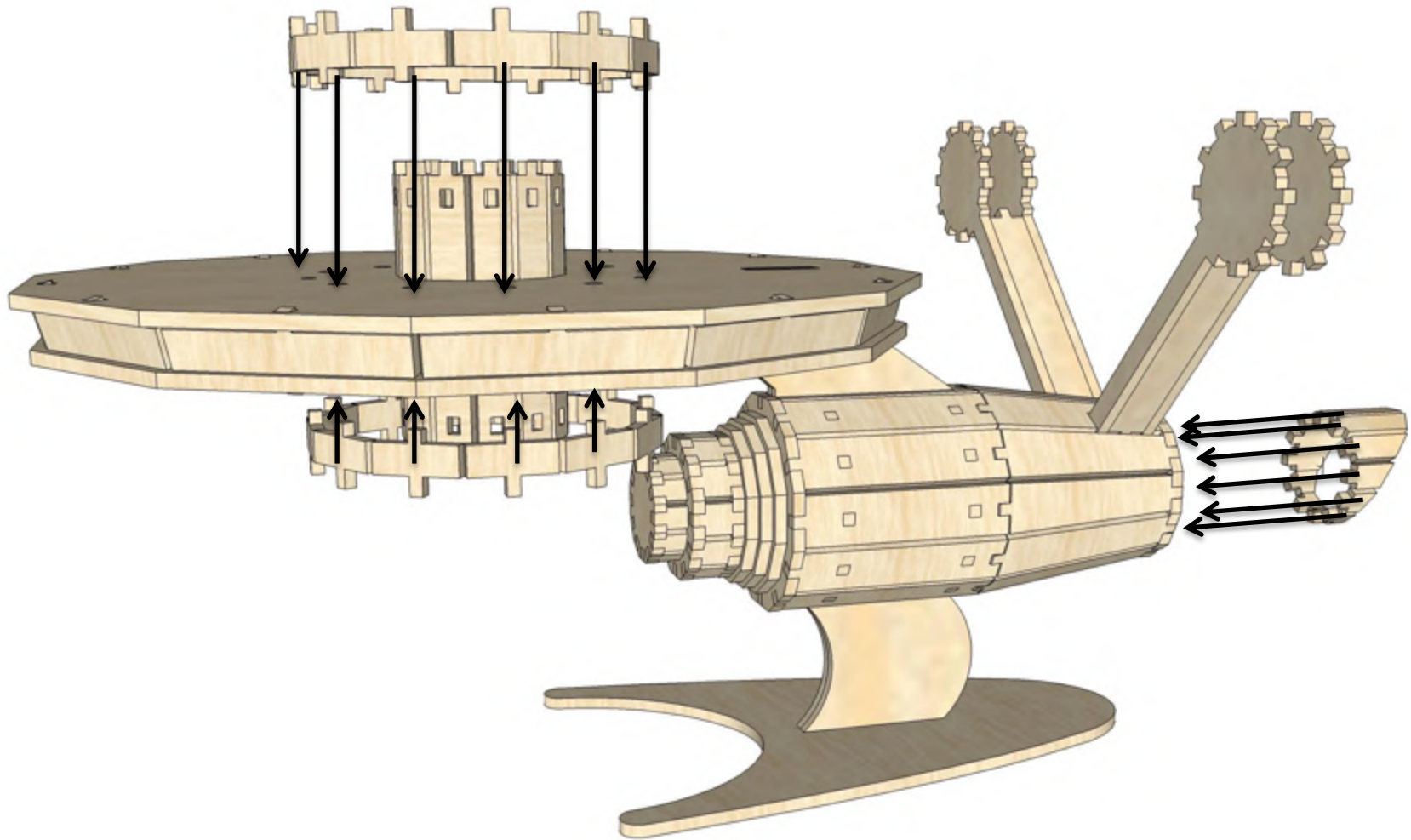

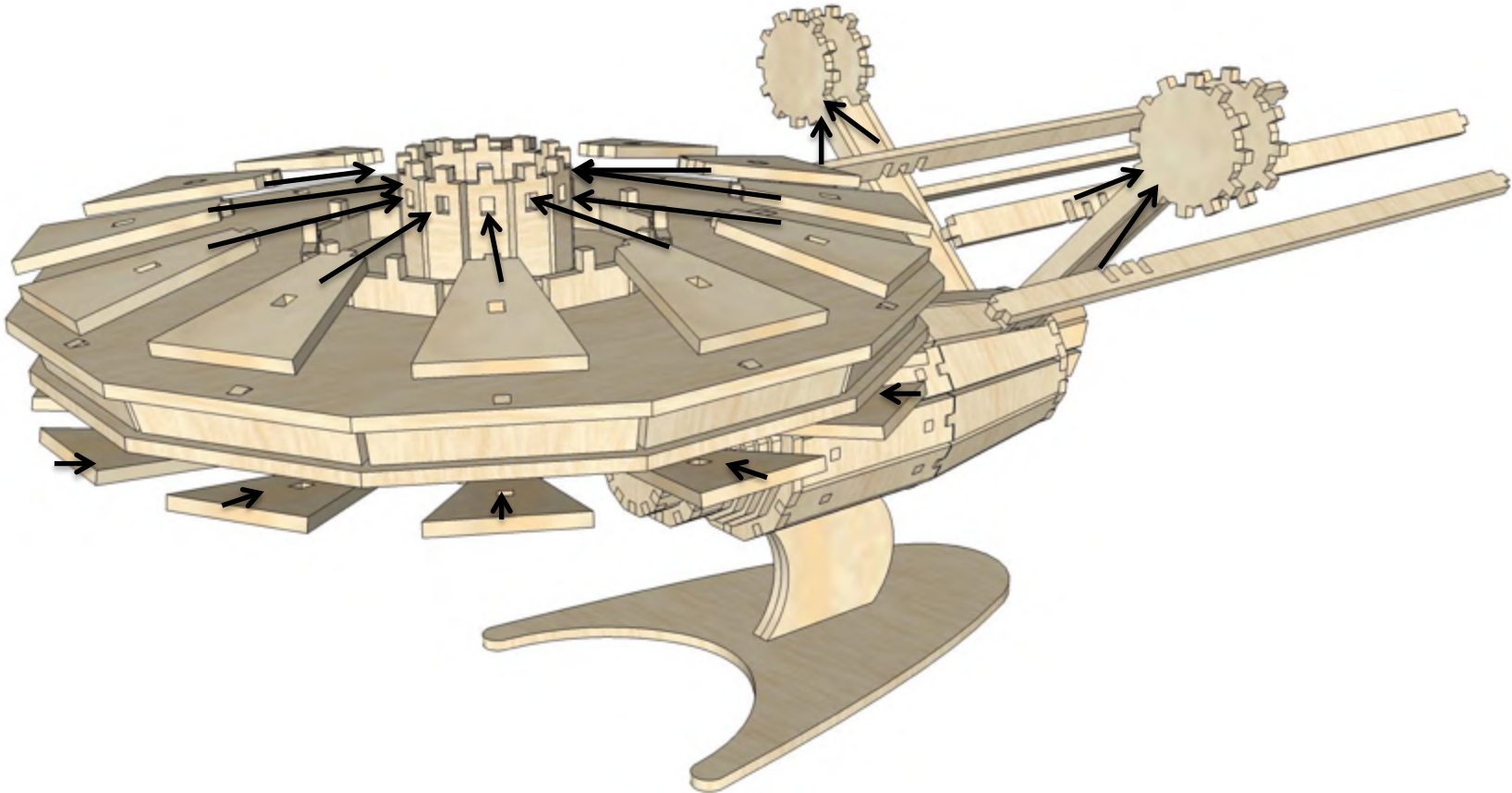

ASSEMBLY STEPS



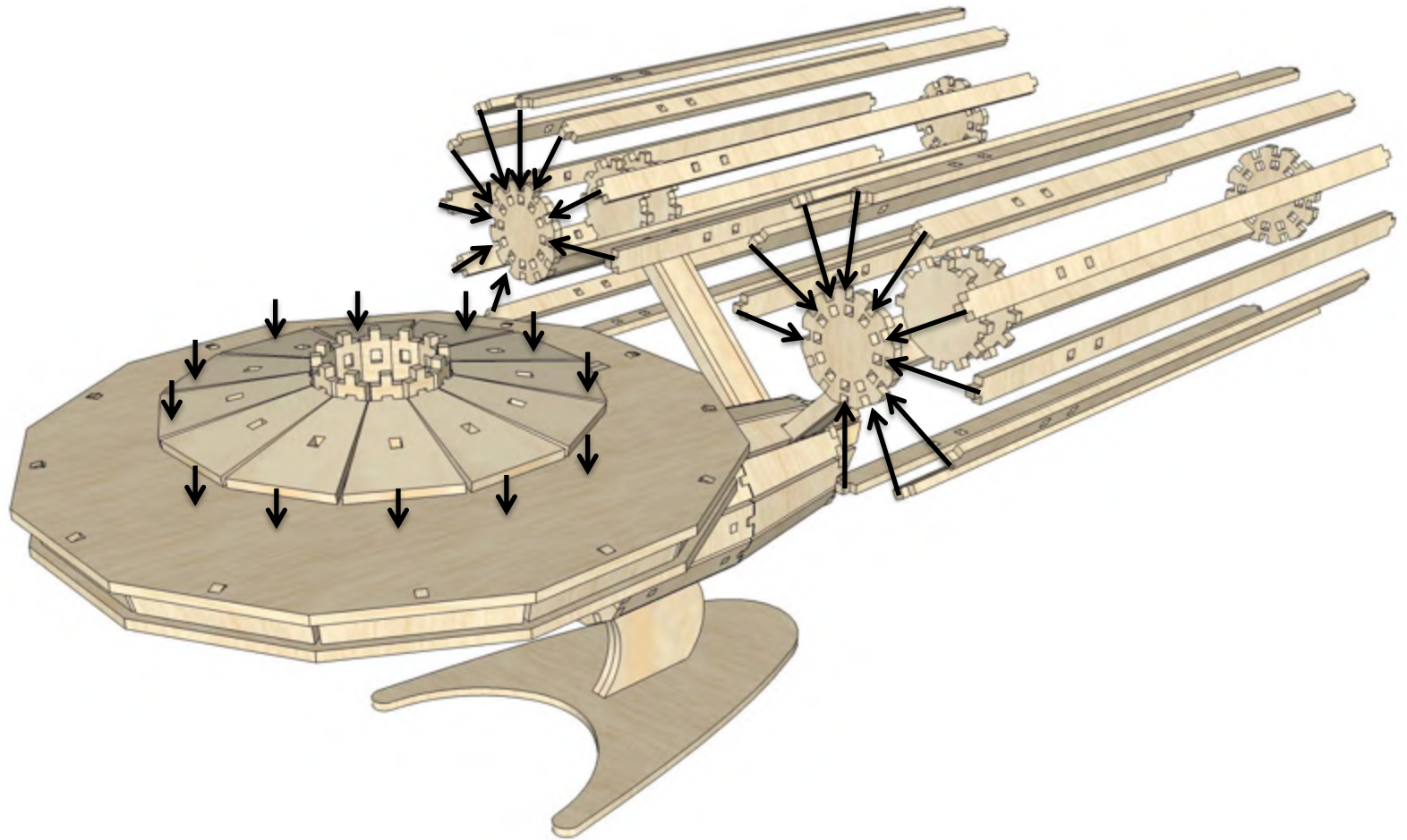

ASSEMBLY STEPS



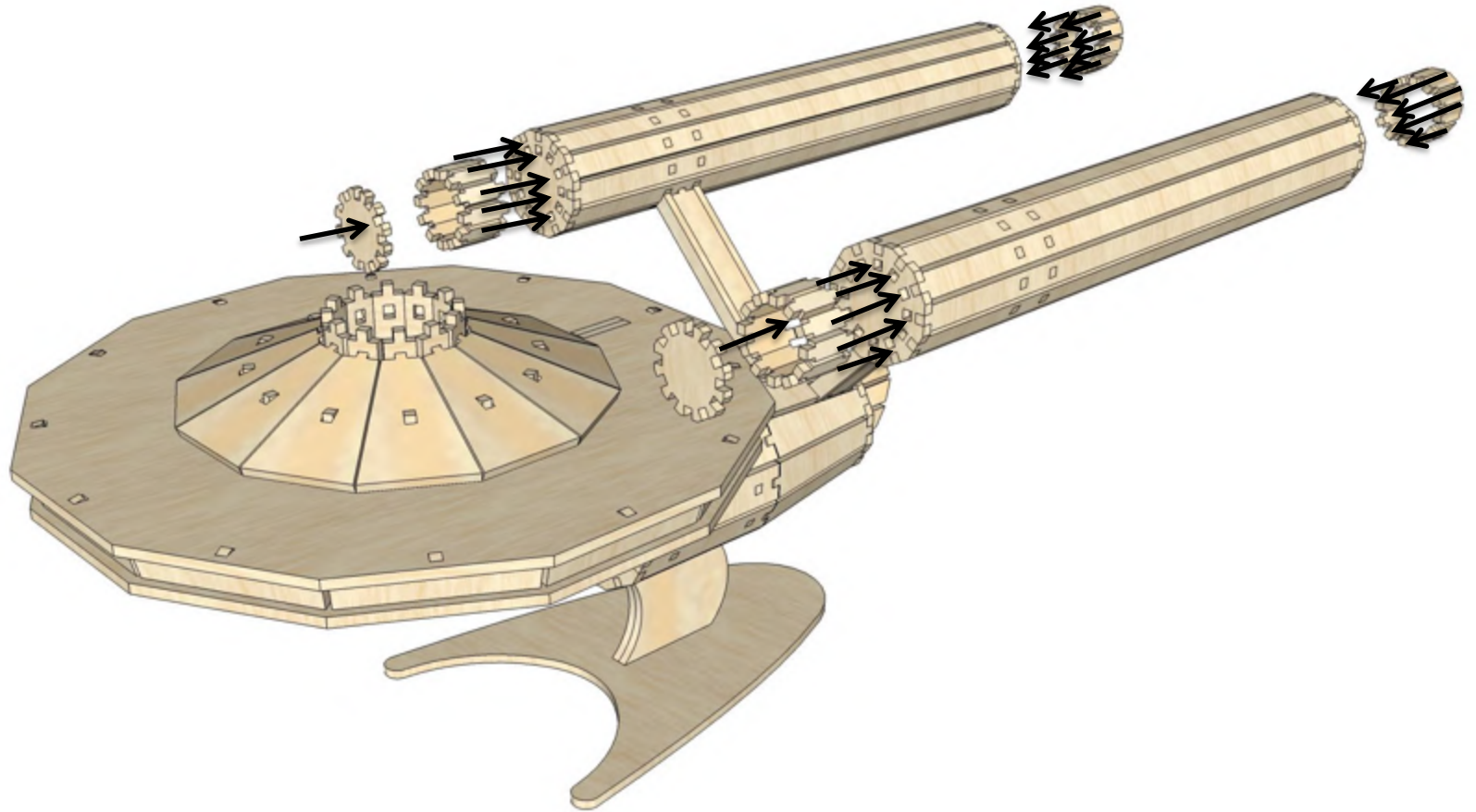

ASSEMBLY STEPS



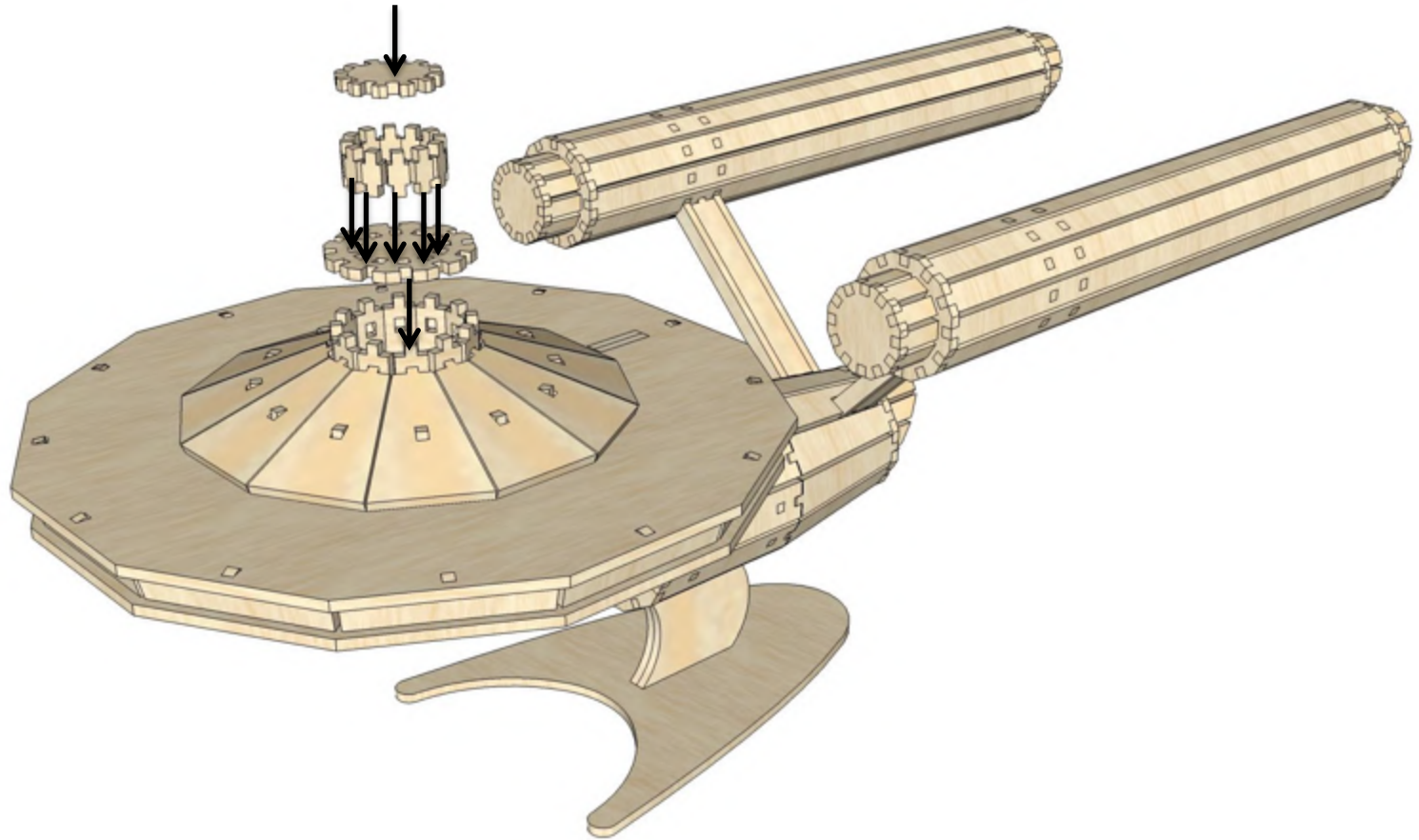

ASSEMBLY STEPS



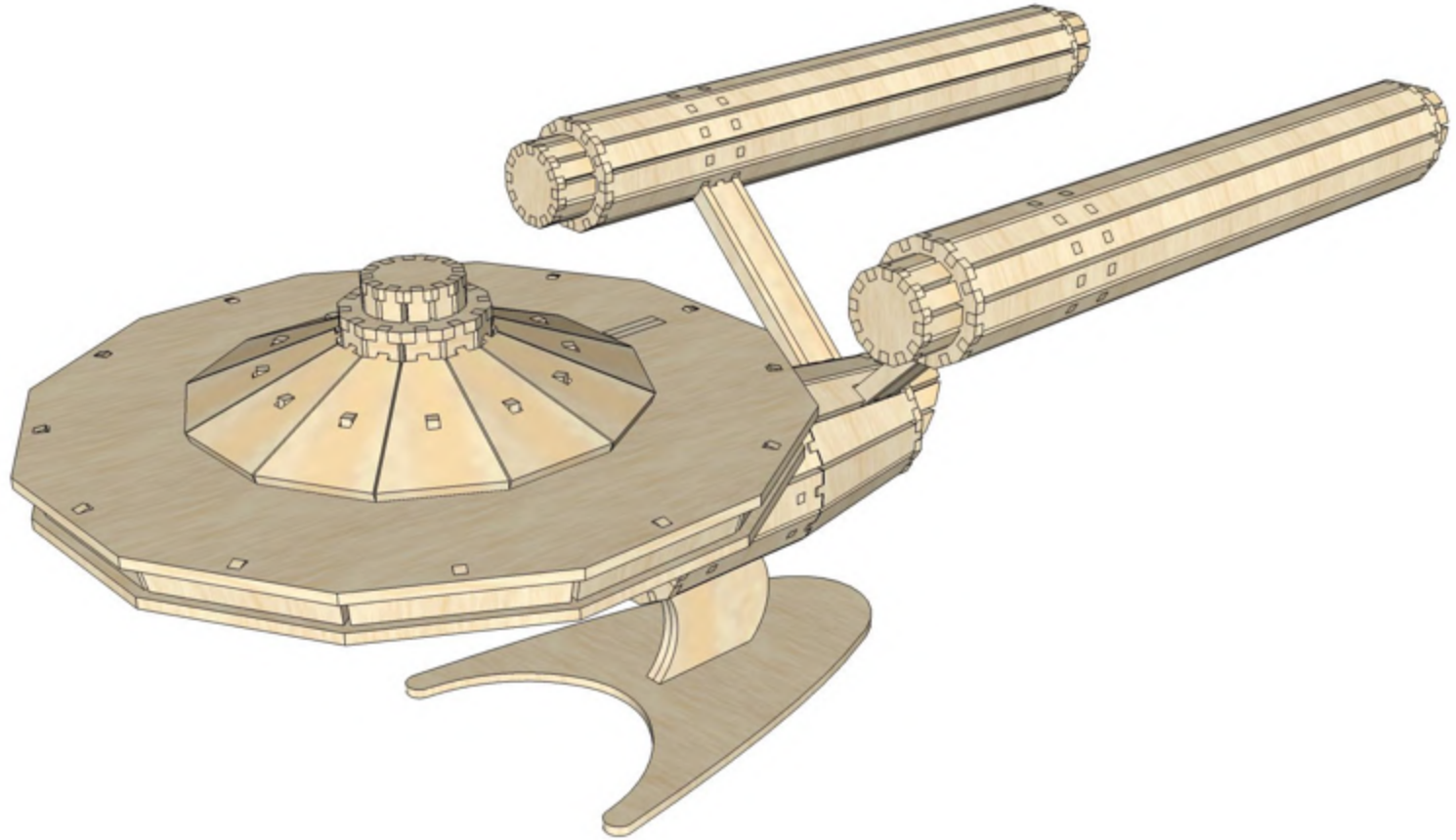

COMPLETED





COMPLETED

